



劲普机械
Jinpu Mechanical



杭州劲普传动机械有限公司

Hangzhou Jinpu Transmission Mechanical Co., Ltd

www.jpmach.com

中国·浙江
ZHEJIANG CHINA



公司简介 COMPANY PROFILE

Jinpu, An Enterprise in Zhejiang China, is established over 10 years, 50~100 staff, and an area coverage of 5,000+ square meters for 2 manufacturing plants. Our business scope covers manufacturing Sprocket, Gear, Timing Belt Pulley, Taper Bush, Industrial Chain, mainly focus on non-standard machining parts base on customers' drawings.



Taper Bore V-pulleys



SPZ - SPA - SPB - SPC *BS3790 - 1981*

TYPE	PD(mm)	a°	f	e	g	h	b
Z-SPZ	≤80	34	8	12	9.7	9	2
	>80	38			9.9		
A-SPA	≤118	34	10	15	12.7	11	2.75
	>118	38			12.9		
B-SPB	≤190	34	12.5	19	16.1	14	3.5
	>190	38			16.4		
C-SPC	≤315	34	17	25.5	21.9	19	4.8
	>315	38			22.3		

Taper Bore V-pulleys

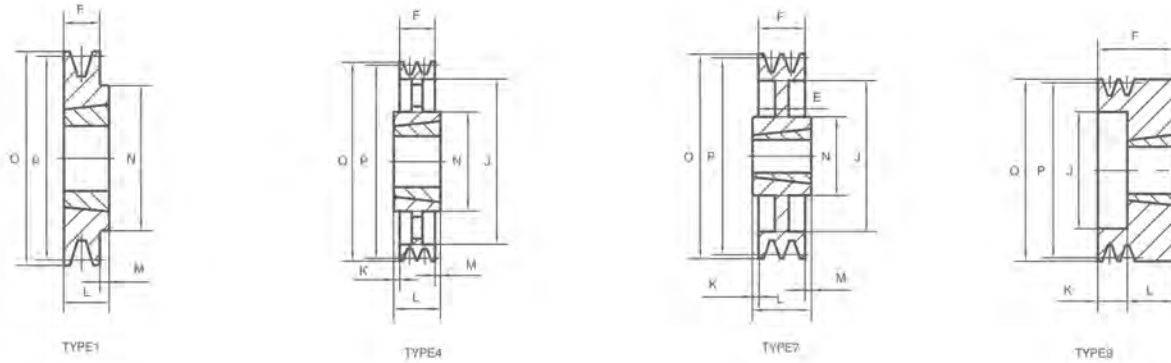

SPZ-1

ITEM NO.	NO.OF GROOVES	PD	O.D	TYPE	BUSH NO.	MAX BORE	E	F	J	K	L	M	N
SPZ 50-01	1	50.0	54.0	9	1008	25	—	37	28	15	22	—	—
SPZ 56-01	1	56.0	60.0	9	1008	25	—	37	33	15	22	—	—
SPZ 60-01	1	60.0	64.0	9	1008	25	—	22	—	—	22	—	—
SPZ 63-01	1	63.0	67.0	1	1108	28	—	16	—	—	22	6	62
SPZ 67-01	1	67.0	71.0	1	1108	28	—	16	—	—	22	6	62
SPZ 71-01	1	71.0	75.0	1	1108	28	—	16	—	—	22	6	62
SPZ 75-01	1	75.0	79.0	1	1108	28	—	16	—	—	22	6	62
SPZ 80-01	1	80.0	84.0	1	1210	32	—	16	—	—	25	9	75
SPZ 85-01	1	85.0	89.0	1	1210	32	—	16	—	—	25	9	75
SPZ 90-01	1	90.0	94.0	1	1210	32	—	16	—	—	25	9	75
SPZ 95-01	1	95.0	99.0	1	1210	32	—	16	—	—	25	9	75
SPZ100-01	1	100.0	104.0	1	1210	32	—	16	—	—	25	9	75
SPZ106 -01	1	106.0	110.0	1	1610	42	—	16	—	—	25	9	80
SPZ112-01	1	112.0	116.0	1	1610	42	—	16	—	—	25	9	80
SPZ118-01	1	118.0	122.0	1	1610	42	—	16	—	—	25	9	80
SPZ125-01	1	125.0	129.0	1	1610	42	—	16	—	—	25	9	80
SPZ132-01	1	132.0	136.0	1	1610	42	—	16	—	—	25	9	80
SPZ140-01	1	140.0	144.0	1	1610	42	—	16	—	—	25	9	80
SPZ150-01	1	150.0	154.0	1	1610	42	—	16	—	—	25	9	80
SPZ160-01	1	160.0	164.0	1	1610	42	—	16	—	—	25	9	80
SPZ170-01	1	170.0	174.0	1	1610	42	—	16	—	—	25	9	80
SPZ180-01	1	180.0	184.0	1	1610	42	—	16	—	—	25	9	80
SPZ190-01	1	190.0	194.0	7	1610	42	15	16	161	—	25	9	80
SPZ200-01	1	200.0	204.0	7	2012	50	15	16	172	—	32	16	100
SPZ224-01	1	224.0	228.0	7	2012	50	15	16	196	—	32	16	100
SPZ250-01	1	250.0	254.0	4	2012	50	—	16	222	8	32	8	100
SPZ280-01	1	280.0	284.0	4	2012	50	—	16	252	8	32	8	100
SPZ315-01	1	315.0	319.0	4	2012	50	—	16	287	8	32	8	100
SPZ355-01	1	355.0	359.0	4	2012	50	—	16	326	8	32	8	112
SPZ400-01	1	400.0	404.0	4	2012	50	—	16	371	8	32	8	112
SPZ450-01	1	450.0	454.0	4	2517	60	—	16	421	14.5	45	14.5	120

Taper Bore V-pulleys

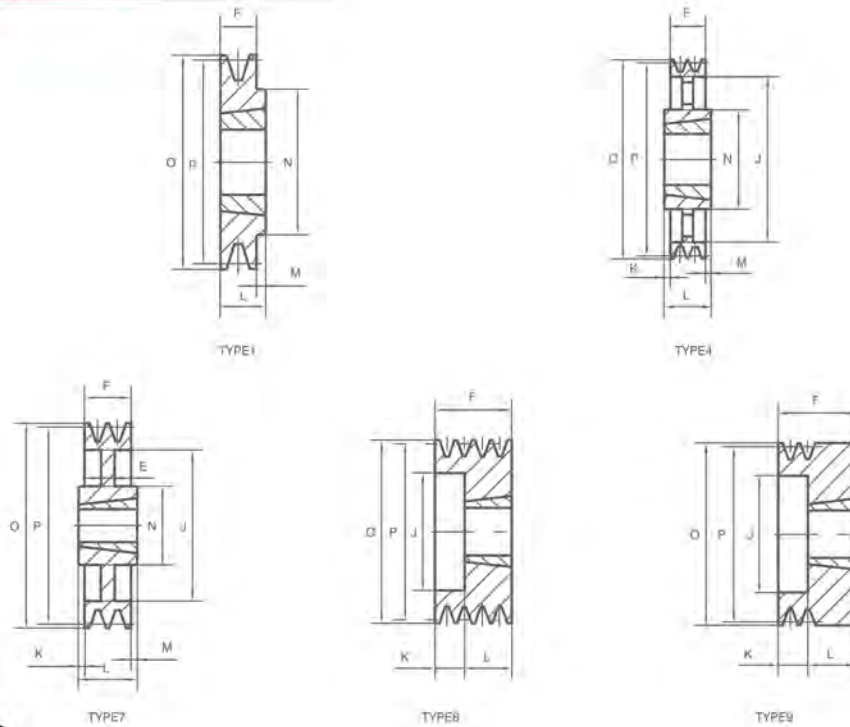

SPZ-2

ITEM NO.	NO.OF GROOVES	PD	O.D	TYPE	BUSH NO.	MAX BORE	E	F	J	K	L	M	N
SPZ 50-02	2	50.0	54.0	9	1008	25	—	49	28	27	22	—	—
SPZ 56-02	2	56.0	60.0	9	1108	28	—	49	35	27	22	—	—
SPZ 60-02	2	60.0	64.0	9	1108	28	—	49	36	27	22	—	—
SPZ 63-02	2	63.0	67.0	8	1108	28	—	28	40	6	22	—	—
SPZ 67-02	2	67.0	71.0	8	1108	28	—	28	42	6	22	—	—
SPZ 71-02	2	71.0	75.0	8	1108	28	—	28	42	6	22	—	—
SPZ 75-02	2	75.0	79.0	8	1210	32	—	28	51	3	25	—	—
SPZ 80-02	2	80.0	84.0	8	1210	32	—	28	51	3	25	—	—
SPZ 85-02	2	85.0	89.0	8	1610	42	—	28	60	3	25	—	—
SPZ 90-02	2	90.0	94.0	8	1610	42	—	28	61	3	25	—	—
SPZ 95-02	2	95.0	99.0	8	1610	42	—	28	66	3	25	—	—
SPZ100-02	2	100.0	104.0	8	1610	42	—	28	71	3	25	—	—
SPZ106-02	2	106.0	110.0	8	1610	42	—	28	76	3	25	—	—
SPZ112-02	2	112.0	116.0	8	1610	42	—	28	84	3	25	—	—
SPZ118-02	2	118.0	122.0	8	1610	42	—	28	90	3	25	—	—
SPZ125-02	2	125.0	129.0	8	1610	42	—	28	97	3	25	—	—
SPZ132-02	2	132.0	136.0	8	1610	42	—	28	104	3	25	—	—
SPZ140-02	2	140.0	146.0	8	1610	42	—	28	112	3	25	—	—
SPZ150-02	2	150.0	154.0	1	2012	50	—	28	—	—	32	4	100
SPZ160-02	2	160.0	164.0	1	2012	50	—	28	—	—	32	4	100
SPZ170-02	2	170.0	174.0	1	2012	50	—	28	—	—	32	4	100
SPZ180-02	2	180.0	184.0	7	2012	50	10	28	152	—	32	4	100
SPZ190-02	2	190.0	194.0	7	2012	50	10	28	161	—	32	4	100
SPZ200-02	2	200.0	204.0	7	2012	50	10	28	171	—	32	4	100
SPZ224-02	2	224.0	228.0	7	2012	50	10	28	196	—	32	4	100
SPZ250-02	2	250.0	254.0	4	2012	50	—	28	222	2	32	2	100
SPZ280-02	2	280.0	284.0	4	2012	50	—	28	252	2	32	2	100
SPZ315-02	2	315.0	319.0	4	2012	50	—	28	286	2	32	2	100
SPZ355-02	2	355.0	359.0	4	2012	50	—	28	326	2	32	2	112
SPZ400-02	2	400.0	404.0	4	2517	50	—	28	371	8.5	45	8.5	120
SPZ450-02	2	450.0	454.0	4	2517	60	—	28	421	8.5	45	8.5	120

Taper Bore V-pulleys

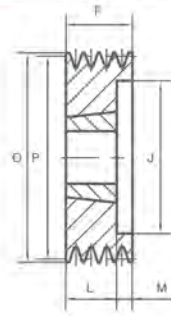

TYPE2

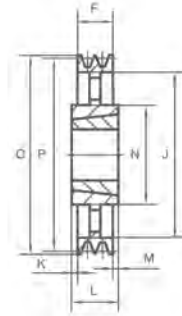

TYPE4

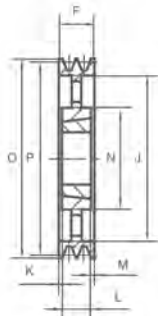

TYPE5

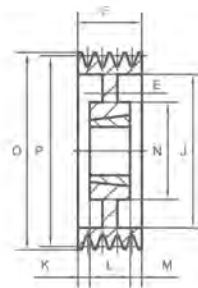

TYPE6

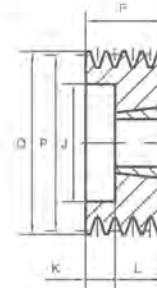

TYPE8

SPZ-3

ITEM NO.	NO.OF GROOVES	PD	O.D	TYPE	BUSH NO.	MAX BORE	E	F	J	K	L	M	N
SPZ 63-03	3	63.0	67.0	8	1108	28	—	40	40	18	22	—	—
SPZ 67-03	3	67.0	71.0	8	1108	28	—	40	42	18	22	—	—
SPZ 71-03	3	71.0	75.0	8	1108	28	—	40	42	18	22	—	—
SPZ 75-03	3	75.0	79.0	8	1210	32	—	40	48	15	25	—	—
SPZ 80-03	3	80.0	84.0	8	1210	32	—	40	51	15	25	—	—
SPZ 85-03	3	85.0	89.0	8	1610	42	—	40	60	15	25	—	—
SPZ 90-03	3	90.0	94.0	8	1610	42	—	40	61	15	25	—	—
SPZ 95-03	3	95.0	99.0	8	1610	42	—	40	66	15	25	—	—
SPZ 100-03	3	100.0	104.0	8	1610	42	—	40	71	15	25	—	—
SPZ 106-03	3	106.0	110.0	8	1610	42	—	40	78	15	25	—	—
SPZ 112-03	3	112.0	116.0	8	2012	50	—	40	84	8	32	—	—
SPZ 118-03	3	118.0	122.0	8	2012	50	—	40	92	8	32	—	—
SPZ 125-03	3	125.0	129.0	2	2012	50	—	40	97	—	32	8	—
SPZ 132-03	3	132.0	136.0	2	2012	50	—	40	104	—	32	8	—
SPZ140-03	3	140.0	144.0	2	2012	50	—	40	112	—	32	8	—
SPZ 150-03	3	150.0	154.0	2	2012	50	—	40	122	—	32	8	—
SPZ 160-03	3	160.0	164.0	2	2012	50	—	40	132	—	32	8	—
SPZ 170-03	3	170.0	174.0	2	2012	50	—	40	141	—	32	8	—
SPZ 180-03	3	180.0	184.0	2	2012	50	—	40	152	—	32	8	—
SPZ190-03	3	190.0	194.0	6	2012	50	20	40	161	4	32	4	100
SPZ 200-03	3	200.0	204.0	6	2012	50	20	40	172	4	32	4	100
SPZ 224-03	3	224.0	228.0	6	2012	50	20	40	196	4	32	4	100
SPZ 250-03	3	250.0	254.0	5	2012	50	—	40	222	4	32	4	100
SPZ 280-03	3	280.0	284.0	4	2517	50	—	40	252	2.5	45	2.5	120
SPZ 315-03	3	315.0	319.0	4	2517	50	—	40	287	2.5	45	2.5	120
SPZ 355-03	3	355.0	359.0	4	2517	60	—	40	326	2.5	45	2.5	120
SPZ 400-03	3	400.0	404.0	4	2517	60	—	40	371	2.5	45	2.5	120
SPZ 450-03	3	450.0	454.0	4	2517	60	—	40	421	2.5	45	2.5	120
SPZ 500-03	3	500.0	504.0	4	2517	60	—	40	471	2.5	45	2.5	120
SPZ 630-03	3	630.0	634.0	4	2517	60	—	40	601	2.5	45	2.5	120
SPZ 800-03	3	800.0	804.0	4	3020	75	—	40	771	2.5	51	5.5	150

Taper Bore V-pulleys

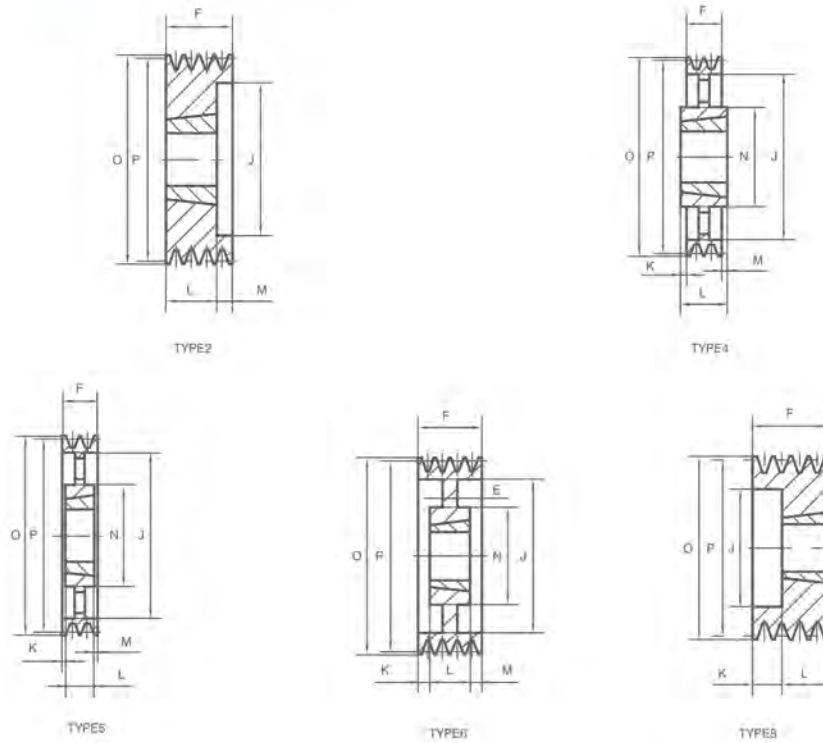

SPZ-4

ITEM NO.	NO.OF GROOVES	P.D	O.D	TYPE	BUSH NO.	MAX BORE	E	F	J	K	L	M	N
SPZ 80-04	4	80.0	84.0	8	1210	32	—	52	51	27	25	—	—
SPZ 85-04	4	85.0	89.0	8	1610	42	—	52	60	27	25	—	—
SPZ 90-04	4	90.0	94.0	8	1610	42	—	52	61	27	25	—	—
SPZ 95-04	4	95.0	99.0	8	1610	42	—	52	66	27	25	—	—
SPZ100-04	4	100.0	104.0	8	1610	42	—	52	72	27	25	—	—
SPZ106-04	4	106.0	110.0	8	1610	42	—	52	80	27	25	—	—
SPZ112-04	4	112.0	116.0	8	2012	50	—	52	86	20	32	—	—
SPZ118-04	4	118.0	122.0	8	2012	50	—	52	92	20	32	—	—
SPZ125-04	4	125.0	129.0	2	2012	50	—	52	99	20	32	20	—
SPZ132-04	4	132.0	136.0	2	2012	50	—	52	104	20	32	20	—
SPZ140-04	4	140.0	144.0	2	2012	50	—	52	112	7	32	20	—
SPZ150-04	4	150.0	154.0	2	2517	60	—	52	122	7	45	7	—
SPZ160-04	4	160.0	164.0	2	2517	60	—	52	132	—	45	7	—
SPZ170-04	4	170.0	174.0	2	2517	60	—	52	141	—	45	7	—
SPZ180-04	4	180.0	184.0	2	2517	60	—	52	152	—	45	7	—
SPZ190-04	4	190.0	194.0	6	2517	60	10	52	161	3.5	45	3.5	120
SPZ200-04	4	200.0	204.0	6	2517	60	10	52	172	3.5	45	3.5	120
SPZ224-04	4	224.0	228.0	6	2517	60	10	52	196	3.5	45	3.5	120
SPZ250-04	4	250.0	254.0	5	2517	60	—	52	222	3.5	45	3.5	120
SPZ280-04	4	280.0	284.0	5	2517	60	—	52	252	3.5	45	3.5	120
SPZ315-04	4	315.0	319.0	5	2517	60	—	52	287	3.5	45	3.5	120
SPZ355-04	4	355.0	359.0	5	2517	60	—	52	326	3.5	45	3.5	120
SPZ400-04	4	400.0	404.0	5	2517	60	—	52	371	3.5	45	3.5	120
SPZ450-04	4	450.0	454.0	5	3020	75	—	52	421	0.5	51	0.5	150
SPZ500-04	4	500.0	504.0	5	3020	75	—	52	471	0.5	51	0.5	150
SPZ630-04	4	630.0	634.0	4	3030	75	—	52	601	12	76	12	150
SPZ800-04	4	800.0	804.0	4	3030	75	—	52	771	12	76	12	150

Taper Bore V-pulleys

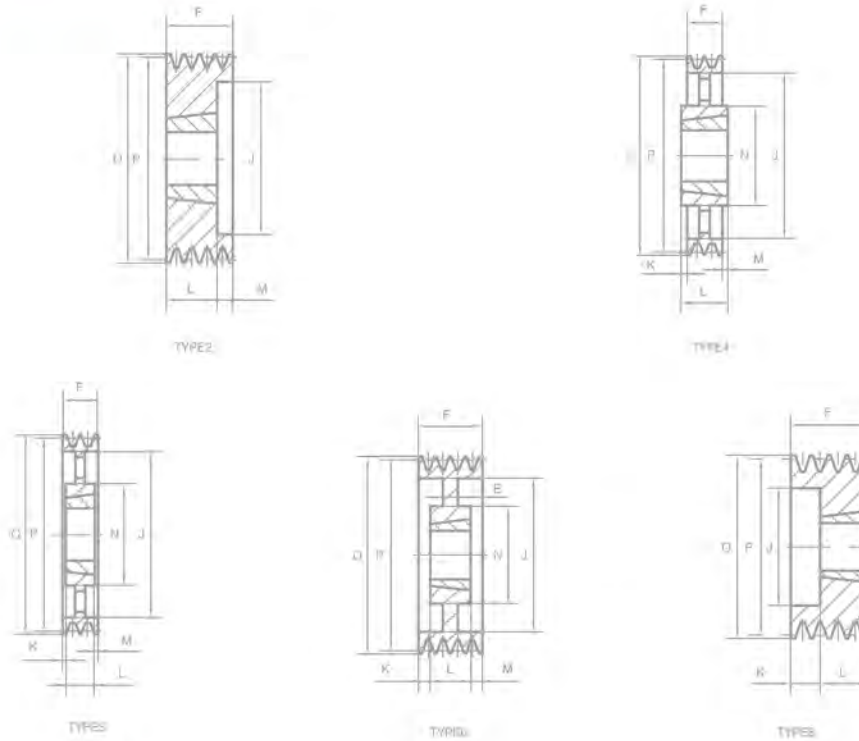

SPZ-5

ITEM NO.	NO.OF GROOVES	PD	O.D	TYPE	BUSH NO.	MAX BORE	E	F	J	K	L	M	N
SPZ 85-05	5	85.0	89.0	8	1610	42	—	64	60	39	25	—	—
SPZ 90-05	5	90.0	94.0	8	1610	42	—	64	61	39	25	—	—
SPZ 95-05	5	95.0	99.0	8	1610	42	—	64	66	39	25	—	—
SPZ100-05	5	100.0	104.0	8	2012	50	—	64	72	32	32	—	—
SPZ106-05	5	106.0	110.0	8	2012	50	—	64	78	32	32	—	—
SPZ112-05	5	112.0	116.0	8	2012	50	—	64	84	32	32	—	—
SPZ118-05	5	118.0	122.0	8	2012	50	—	64	90	32	32	—	—
SPZ125-05	5	125.0	129.0	8	2012	50	—	64	97	32	32	—	—
SPZ132-05	5	132.0	136.0	8	2517	60	—	64	104	19	45	—	—
SPZ140-05	5	140.0	144.0	2	2517	60	—	64	112	—	45	19	—
SPZ150-05	5	150.0	154.0	2	2517	60	—	64	122	—	45	19	—
SPZ160-05	5	160.0	164.0	2	2517	60	—	64	132	—	45	19	—
SPZ170-05	5	170.0	174.0	2	2517	60	—	64	141	—	45	19	—
SPZ180-05	5	180.0	184.0	2	2517	60	—	64	152	—	45	19	—
SPZ190-05	5	190.0	194.0	6	2517	60	10	64	161	9.5	45	9.5	120
SPZ200-05	5	200.0	204.0	6	2517	60	10	64	172	9.5	45	9.5	120
SPZ224-05	5	224.0	228.0	6	2517	60	10	64	196	9.5	45	9.5	120
SPZ250-05	5	250.0	254.0	5	2517	60	—	64	222	9.5	45	9.5	120
SPZ280-05	5	280.0	284.0	5	2517	60	—	64	252	9.5	45	9.5	120
SPZ315-05	5	315.0	319.0	5	2517	60	—	64	287	9.5	45	9.5	120
SPZ355-05	5	355.0	359.0	5	2517	60	—	64	326	9.5	45	9.5	120
SPZ400-05	5	400.0	404.0	5	3020	75	—	64	371	6.5	51	6.5	150
SPZ450-05	5	450.0	454.0	5	3020	75	—	64	421	6.5	51	6.5	150
SPZ500-05	5	500.0	504.0	4	3030	75	—	64	471	6	76	6	150
SPZ630-05	5	630.0	634.0	4	3030	75	—	64	601	6	76	6	150
SPZ800-05	5	800.0	804.0	4	3535	90	—	64	771	12.5	89	12.5	170

Taper Bore V-pulleys

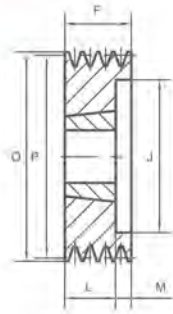

TYPE2

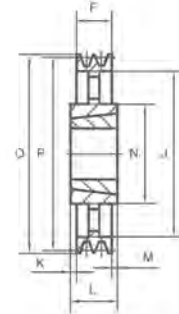

TYPE4

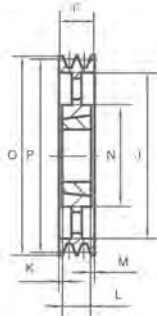

TYPE5

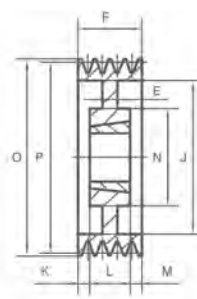

TYPE6

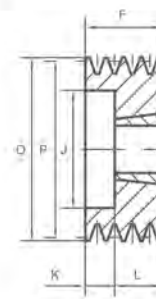

TYPE8

SPZ-6

ITEM NO.	NO.OF GROOVES	PD	O.D	TYPE	BUSH NO.	MAX BORE	E	F	J	K	L	M	N
SPZ 90-06	6	90.0	94.0	8	1610	42	—	76	61	51	25	—	—
SPZ 95-06	6	95.0	99.0	8	1610	42	—	76	66	51	25	—	—
SPZ100-06	6	100.0	104.0	8	2012	50	—	76	72	44	32	—	—
SPZ106-06	6	106.0	110.0	8	2012	50	—	76	78	44	32	—	—
SPZ112-06	6	112.0	116.0	8	2012	50	—	76	84	44	32	—	—
SPZ118-06	6	118.0	122.0	8	2517	60	—	76	90	31	45	—	—
SPZ125-06	6	125.0	129.0	8	2517	60	—	76	97	31	45	—	—
SPZ132-06	6	132.0	136.0	8	2517	60	—	76	104	31	45	—	—
SPZ140-06	6	140.0	146.0	2	2517	60	—	76	112	—	45	31	—
SPZ150-06	6	150.0	154.0	2	2517	60	—	76	122	—	45	31	—
SPZ160-06	6	160.0	164.0	2	2517	60	—	76	132	—	45	31	—
SPZ170-06	6	170.0	174.0	2	2517	60	—	76	141	—	45	31	—
SPZ180-06	6	180.0	184.0	2	2517	60	—	76	152	—	45	31	—
SPZ190-06	6	190.0	194.0	6	2517	60	10	76	161	15.0	45	15.5	120
SPZ200-06	6	200.0	204.0	6	2517	60	10	76	172	15.0	45	15.5	120
SPZ224-06	6	224.0	228.0	6	2517	60	10	76	196	15.5	45	15.5	120
SPZ250-06	6	250.0	254.0	5	2517	60	—	76	222	15.5	45	15.5	120
SPZ280-06	6	280.0	284.0	5	2517	60	—	76	252	15.5	45	15.5	120
SPZ315-06	6	315.0	319.0	5	2517	60	—	76	287	15.5	45	15.5	120
SPZ355-06	6	355.0	359.0	5	2517	60	—	76	326	15.5	45	15.5	125
SPZ400-06	6	400.0	404.0	5	3030	75	—	76	371	—	76	—	150
SPZ450-06	6	450.0	454.0	5	3030	75	—	76	421	—	76	—	150
SPZ500-06	6	500.0	504.0	5	3030	75	—	76	471	—	76	—	150
SPZ630-06	6	630.0	634.0	4	3535	90	—	76	601	6.5	89	6.5	170
SPZ800-06	6	800.0	804.0	4	3535	90	—	76	771	6.5	89	6.5	170

Taper Bore V-pulleys

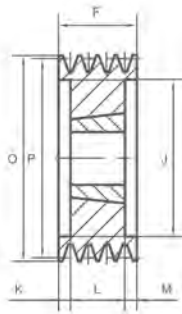

TYPE3

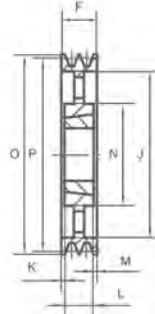

TYPE5

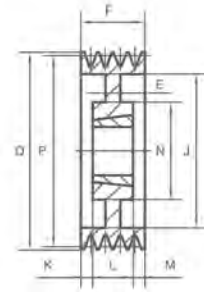

TYPE6

SPZ-8

ITEM NO.	NO.OF GROOVES	P.D	O.D	TYPE	BUSH NO.	MAX BORE	E	F	J	K	L	M	N
SPZ140-08	8	140.0	144.0	3	2517	60	—	100	112	27.5	45	27.5	—
SPZ150-08	8	150.0	154.0	3	2517	60	—	100	122	27.5	45	27.5	—
SPZ160-08	8	160.0	164.0	3	2517	60	—	100	132	27.5	45	27.5	—
SPZ180-08	8	180.0	184.0	3	2517	60	—	100	152	27.5	45	27.5	—
SPZ200-08	8	200.0	204.0	3	3020	75	—	100	171	24.5	51	24.5	—
SPZ224-08	8	224.0	228.0	3	3020	75	—	100	195	24.5	51	24.5	—
SPZ250-08	8	250.0	254.0	6	3020	75	—	100	221	24.5	51	24.5	150
SPZ280-08	8	280.0	284.0	5	3020	75	—	100	252	24.5	51	24.5	150
SPZ355-08	8	355.0	359.0	5	3030	75	—	100	326	12	76	12	150
SPZ400-08	8	400.0	404.0	5	3030	75	—	100	371	12	76	12	150
SPZ450-08	8	450.0	454.0	5	3535	90	—	100	421	5.5	89	5.5	170

Standard bore dimensions of taper bore bushes

Bushing	Stock Bores																								
	20	22	24	25	28	30	32	35	38	40	42	45	48	50	55	60	65	70	75	80	85	90	95	100	
2517	●	●	●	●	●	●	●	●	●	●	●	●	●	●	●	●									
3020				●	●	●	●	●	●	●	●	●	●	●	●	●	●	●	●						
3030				●	●	●	●	●	●	●	●	●	●	●	●	●	●	●	●						
3535								●	●	●	●	●	●	●	●	●	●	●	●	●	●	●			

Taper Bore V-pulleys

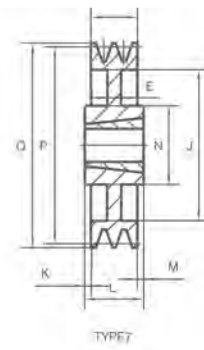
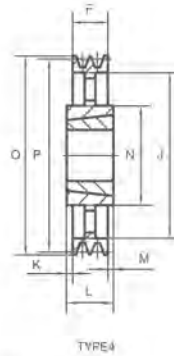
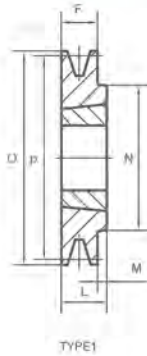

SPA-1

ITEM NO.	NO.OF GROOVES	PD	O.D	TYPE	BUSH NO.	MAX BORE	E	F	J	K	L	M	N
SPA 63-01	1	63.0	68.5	1	1008	28	—	20	—	—	22	2	56
SPA 67-01	1	67.0	72.5	1	1108	28	—	20	—	—	22	2	62
SPA 71-01	1	71.0	76.5	1	1108	28	—	20	—	—	22	2	62
SPA 75-01	1	75.0	80.5	1	1108	28	—	20	—	—	22	2	62
SPA 80-01	1	80.0	85.5	1	1210	32	—	20	—	—	25	5	75
SPA 85-01	1	85.0	90.5	1	1210	32	—	20	—	—	25	5	75
SPA 90-01	1	90.0	95.5	1	1210	32	—	20	—	—	25	5	75
SPA 95-01	1	95.0	100.5	1	1210	32	—	20	—	—	25	5	75
SPA100-01	1	100.0	105.5	1	1610	42	—	20	—	—	25	5	80
SPA106-01	1	106.0	111.5	1	1610	42	—	20	—	—	25	5	80
SPA112-01	1	112.0	117.5	1	1610	42	—	20	—	—	25	5	80
SPA118-01	1	118.0	123.5	1	1610	42	—	20	—	—	25	5	80
SPA125-01	1	125.0	130.5	1	1610	42	—	20	—	—	25	5	80
SPA132-01	1	132.0	137.5	1	1610	42	—	20	—	—	25	5	80
SPA140-01	1	140.0	145.5	1	1610	42	—	20	—	—	25	5	80
SPA150-01	1	150.0	155.5	1	1610	42	—	20	—	—	25	5	80
SPA160-01	1	160.0	165.5	1	1610	42	—	20	—	—	25	5	80
SPA170-01	1	170.0	175.5	1	1610	42	—	20	—	—	25	5	80
SPA180-01	1	180.0	185.5	1	1610	42	—	20	—	—	25	5	80
SPA190-01	1	190.0	195.5	1	1610	42	—	20	—	—	25	5	80
SPA200-01	1	200.0	205.5	7	2012	50	10	20	165	—	32	12	100
SPA224-01	1	224.0	229.5	7	2012	50	10	20	189	—	32	12	100
SPA250-01	1	250.0	255.5	7	2012	50	10	20	215	6	32	6	100
SPA280-01	1	280.0	285.5	7	2012	50	10	20	245	—	32	12	100
SPA315-01	1	315.0	320.5	4	2012	50	—	20	280	—	32	12	100
SPA355-01	1	355.0	360.5	4	2012	50	—	20	320	—	32	12	100
SPA400-01	1	400.0	405.5	4	2012	50	—	20	365	—	32	12	100
SPA450-01	1	450.0	455.5	4	2012	50	—	20	415	—	32	12	100
SPA500-01	1	500.0	505.5	4	2517	60	—	20	465	—	45	25	120
SPA630-01	1	630.0	635.5	4	2517	60	—	20	595	—	45	25	120

Taper Bore V-pulleys

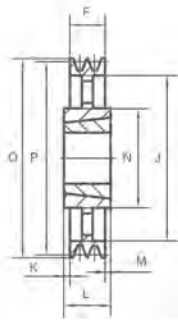

TYPE4

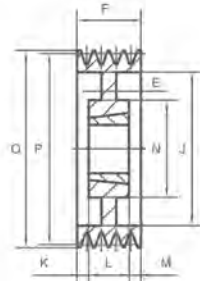

TYPE6

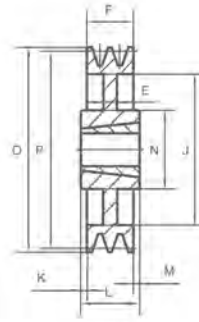

TYPE7

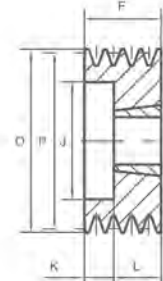

TYPE8

SPA-2

ITEM NO.	NO.OF GROOVES	PD	O.D	TYPE	BUSH NO.	MAX BORE	E	F	J	K	L	M	N
SPA 63-02	2	63.0	68.5	8	1008	28	—	35	36	13	22	—	—
SPA 67-02	2	67.0	72.5	8	1108	28	—	35	37	13	22	—	—
SPA 71-02	2	71.0	76.5	8	1108	28	—	35	40	13	22	—	—
SPA 75-02	2	75.0	80.5	8	1108	28	—	35	44	13	22	—	—
SPA 80-02	2	80.0	85.5	8	1210	32	—	35	47	10	25	—	—
SPA 85-02	2	85.0	90.5	8	1210	32	—	35	50	10	25	—	—
SPA 90-02	2	90.0	95.5	8	1610	42	—	35	60	10	25	—	—
SPA 95-02	2	95.0	100.5	8	1610	42	—	35	64	10	25	—	—
SPA100-02	2	100.0	105.5	8	1610	42	—	35	70	10	25	—	—
SPA106-02	2	106.0	111.5	8	1610	42	—	35	76	10	25	—	—
SPA112-02	2	112.0	117.5	8	1610	42	—	35	80	10	25	—	—
SPA118-02	2	118.0	123.5	8	1610	42	—	35	86	10	25	—	—
SPA125-02	2	125.0	130.5	8	1610	42	—	35	90	10	25	—	—
SPA132-02	2	132.0	137.5	8	2012	50	—	35	98	3	32	—	—
SPA140-02	2	140.0	145.5	8	2012	50	—	35	106	3	32	—	—
SPA150-02	2	150.0	155.5	8	2012	50	—	35	116	3	32	—	—
SPA160-02	2	160.0	165.5	8	2012	50	15	35	125	3	32	—	—
SPA170-02	2	170.0	175.5	8	2012	50	15	35	135	3	32	—	—
SPA180-02	2	180.0	185.5	6	2012	50	15	35	148	1.5	32	1.5	100
SPA190-02	2	190.0	195.5	6	2012	50	15	35	158	1.5	32	1.5	100
SPA200-02	2	200.0	205.5	7	2517	60	15	35	165	5	45	5	120
SPA224-02	2	224.0	229.5	7	2517	60	15	35	189	—	45	10	120
SPA250-02	2	250.0	255.5	7	2517	60	20	35	215	5	45	5	120
SPA280-02	2	280.0	285.5	7	2517	60	20	35	245	—	45	10	120
SPA315-02	2	315.0	320.5	4	2517	60	—	35	280	—	45	10	120
SPA355-02	2	355.0	360.5	4	2517	60	—	35	320	—	45	10	120
SPA400-02	2	400.0	405.5	4	2517	60	—	35	365	—	45	10	120
SPA500-02	2	500.0	505.5	4	2517	60	—	35	465	—	45	10	120
SPA560-02	2	560.0	565.5	4	3020	75	—	35	525	—	51	16	150
SPA630-02	2	630.0	635.5	4	3020	75	—	35	595	—	51	16	150

Taper Bore V-pulleys

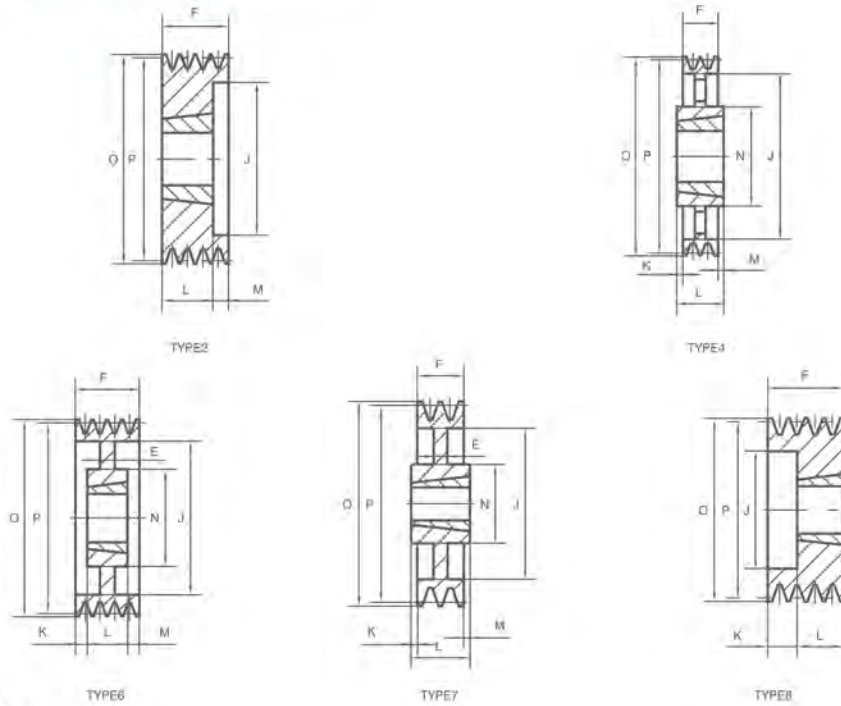

SPA-3

ITEM NO.	NO.OF GROOVES	PD	O.D	TYPE	BUSH NO.	MAX BORE	E	F	J	K	L	M	N
SPA 71-03	3	71.0	76.5	8	1108	28	—	50	40	28	22	—	—
SPA 75-03	3	75.0	80.5	8	1108	32	—	50	44	28	22	—	—
SPA 80-03	3	80.0	85.5	8	1210	32	—	50	47	25	25	—	—
SPA 85-03	3	85.0	90.5	8	1210	32	—	50	50	25	25	—	—
SPA 90-03	3	90.0	95.5	8	1610	42	—	50	60	25	25	—	—
SPA 95-03	3	95.0	100.5	8	1610	42	—	50	64	25	25	—	—
SPA100-03	3	100.0	105.5	2	1610	42	—	50	70	—	25	25	—
SPA106-03	3	106.0	111.5	2	1610	42	—	50	76	—	25	25	—
SPA112-03	3	112.0	117.5	8	2012	50	—	50	83	18	32	—	—
SPA118-03	3	118.0	123.5	2	2012	50	—	50	86	—	32	18	—
SPA125-03	3	125.0	128.5	2	2012	50	—	50	92	—	32	18	—
SPA132-03	3	132.0	137.5	2	2012	50	—	50	98	—	32	18	—
SPA140-03	3	140.0	145.5	8	2517	60	—	50	106	5	45	—	—
SPA150-03	3	150.0	155.5	8	2517	60	—	50	116	5	45	—	—
SPA160-03	3	160.0	165.5	8	2517	60	—	50	126	5	45	—	—
SPA170-03	3	170.0	175.5	8	2517	60	—	50	138	5	45	—	—
SPA180-03	3	180.0	185.5	8	2517	60	—	50	146	5	45	—	—
SPA190-03	3	190.0	195.5	8	2517	60	—	50	158	5	45	—	—
SPA200-03	3	200.0	205.5	6	2517	60	20	50	165	2.5	45	2.5	120
SPA224-03	3	224.0	229.5	6	2517	60	20	50	189	2.5	45	2.5	120
SPA250-03	3	250.0	255.5	6	2517	60	20	50	215	2.5	45	2.5	120
SPA280-03	3	280.0	285.5	6	2517	60	20	50	245	2.5	45	2.5	120
SPA315-03	3	315.0	320.5	7	3020	75	25	50	280	0.5	51	0.5	150
SPA355-03	3	355.0	360.5	4	3020	75	—	50	320	0.5	51	0.5	160
SPA400-03	3	400.0	405.5	4	3020	75	—	50	365	0.5	51	0.5	150
SPA450-03	3	450.0	455.5	4	3020	75	—	50	415	0.5	51	0.5	150
SPA500-03	3	500.0	505.5	4	3020	75	—	50	465	0.5	51	0.5	150
SPA560-03	3	560.0	565.5	4	3020	75	—	50	525	0.5	51	0.5	150
SPA630-03	3	630.0	635.5	4	3020	75	—	50	595	0.5	51	0.5	150
SPA800-03	3	800.0	805.5	4	3535	90	—	50	765	19.5	89	19.5	170
SPA1000-03	3	1000.0	1005.5	4	3535	90	—	50	965	195	89	19.5	178

Taper Bore V-pulleys

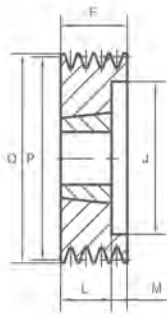

TYPE2

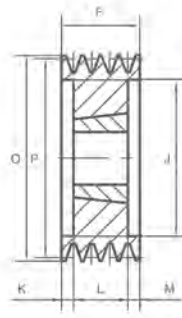

TYPE3

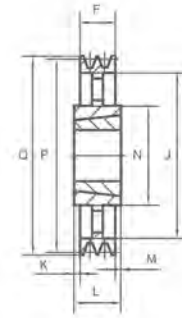

TYPE4

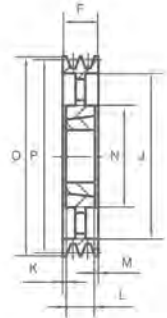

TYPE5

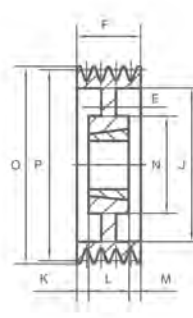

TYPE6

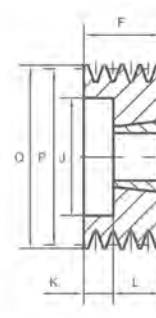

TYPE8

SPA-4

ITEM NO.	NO.OF GROOVES	PD	O.D	TYPE	BUSH NO.	MAX BORE	E	F	J	K	L	M	N
SPA 90-04	4	90.0	95.5	3	1615	42	—	65	64	13.5	38	13.5	—
SPA 95-04	4	95.0	100.5	3	1615	42	—	65	64	13.5	38	13.5	—
SPA100-04	4	100.0	105.5	2	1615	42	—	65	70	-	38	27	—
SPA106-04	4	106.0	111.5	8	2012	50	—	65	76	33	32	—	—
SPA112-04	4	112.0	117.5	8	2012	50	—	65	80	33	32	—	—
SPA118-04	4	118.0	123.5	2	2012	50	—	65	86	—	32	33	—
SPA125-04	4	125.0	130.5	2	2012	50	—	65	92	—	32	33	—
SPA132-04	4	132.0	137.5	2	2517	60	—	65	98	—	45	20	—
SPA140-04	4	140.0	145.5	2	2517	60	—	65	106	—	45	20	—
SPA150-04	4	150.0	155.5	2	2517	60	—	65	116	—	45	20	—
SPA160-04	4	160.0	165.5	2	2517	60	—	65	126	—	45	20	—
SPA170-04	4	170.0	175.5	2	2517	60	—	65	138	—	45	20	—
SPA180-04	4	180.0	185.5	2	2517	60	—	65	146	—	45	20	—
SPA190-04	4	190.0	195.5	2	2517	60	—	65	158	—	45	20	—
SPA200-04	4	200.0	205.5	2	3020	75	—	65	165	—	51	14	—
SPA224-04	4	224.0	229.5	2	3020	75	—	65	189	—	51	14	—
SPA250-04	4	250.0	255.5	6	3020	75	10	65	215	7	51	7	150
SPA280-04	4	280.0	285.5	6	3020	75	10	65	245	7	51	7	150
SPA315-04	4	315.0	320.5	6	3020	75	10	65	280	7	51	7	150
SPA355-04	4	355.0	360.5	5	3020	75	—	65	320	7	51	7	150
SPA400-04	4	400.0	405.5	5	3020	75	—	65	365	7	51	7	150
SPA450-04	4	450.0	455.5	5	3020	75	—	65	415	7	51	7	150
SPA500-04	4	500.0	505.5	5	3020	75	—	65	465	7	51	7	150
SPA560-04	4	560.0	565.5	4	3535	90	—	65	525	12	89	12	170
SPA630-04	4	630.0	635.5	4	3535	90	—	65	595	12	89	12	170
SPA800-04	4	800.0	805.5	4	3535	90	—	65	765	12	89	12	170
SPA1000-04	4	1000.0	1005.5	4	4040	100	—	65	965	18.5	102	18.5	216

Taper Bore V-pulleys

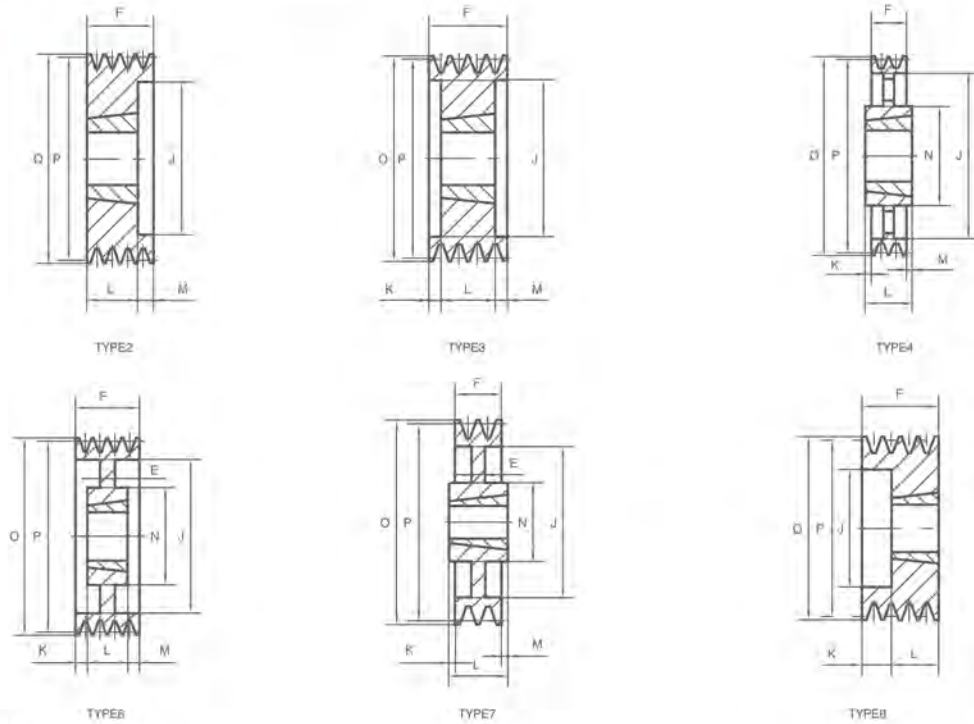

SPA-5

ITEM NO.	NO.OF GROOVES	PD	O.D	TYPE	BUSH NO.	MAX BORE	E	F	J	K	L	M	N
SPA100-05	5	100.0	105.5	2	1615	42	—	80	70	—	38	42	—
SPA106-05	5	106.0	111.5	8	2012	50	—	80	76	48	32	—	—
SPA112-05	5	112.0	117.5	8	2012	50	—	80	80	48	32	—	—
SPA118-05	5	118.0	123.5	2	2012	50	—	80	86	—	32	48	—
SPA125-05	5	125.0	130.5	3	2012	50	—	80	92	24	32	24	—
SPA132-05	5	132.0	137.5	3	2517	60	—	80	98	17.5	45	17.5	—
SPA140-05	5	140.0	145.5	3	2517	60	—	80	106	17.5	45	17.5	—
SPA150-05	5	150.0	155.5	3	2517	60	—	80	116	17.5	45	17.5	—
SPA160-05	5	160.0	165.5	3	2517	60	—	80	126	17.5	45	17.5	—
SPA180-05	5	180.0	185.5	3	3020	75	—	80	146	14.5	51	14.5	—
SPA200-05	5	200.0	205.5	3	3020	75	—	80	165	14.5	51	14.5	—
SPA224-05	5	224.0	229.5	2	3020	75	—	80	189	—	51	29	—
SPA250-05	5	250.0	255.5	6	3020	75	10	80	215	14.5	51	14.5	150
SPA280-05	5	280.0	285.5	7	3535	90	10	80	245	4.5	89	4.5	170
SPA315-05	5	315.0	320.5	7	3535	90	12	80	280	4.5	89	4.5	170
SPA355-05	5	355.0	360.5	4	3535	90	—	80	320	4.5	89	4.5	170
SPA400-05	5	400.0	405.5	4	3535	90	—	80	365	4.5	89	4.5	170
SPA450-05	5	450.0	455.5	4	3535	90	—	80	415	4.5	89	4.5	170
SPA500-05	5	500.0	505.5	4	3535	90	—	80	465	4.5	89	4.5	170
SPA560-05	5	560.0	565.5	4	3535	90	—	80	525	4.5	89	4.5	170
SPA630-05	5	630.0	635.5	4	3535	90	—	80	595	4.5	89	4.5	170
SPA800-05	5	800.0	805.5	4	4040	100	—	80	765	11	102	11	216
SPA1000-05	5	1000.0	1005.5	4	4545	110	—	80	965	17	114	17	225

Taper Bore V-pulleys

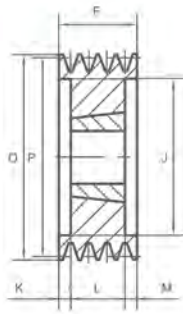

TYPE3

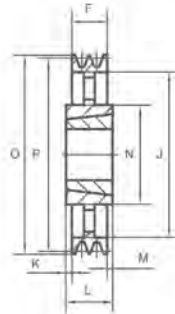

TYPE4

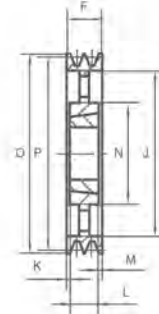

TYPE5

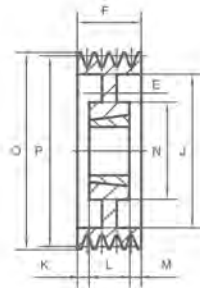

TYPE6

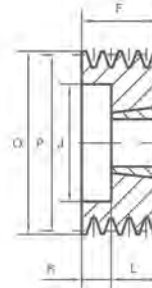

TYPE8

SPA-6

ITEM NO.	NO.OF GROOVES	PD	O.D	TYPE	BUSH NO.	MAX BORE	E	F	J	K	L	M	N
SPA100-06	6	100.0	105.5	3	1615	42	—	95	70	28.5	38	28.5	—
SPA106-06	6	106.0	111.5	8	2012	50	—	95	76	63	32	—	—
SPA112-06	6	112.0	117.5	8	2012	50	—	95	80	63	32	—	—
SPA118-06	6	118.0	123.5	8	2012	50	—	95	86	63	32	—	—
SPA125-06	6	125.0	130.5	3	2012	50	—	95	92	31.5	32	31.5	—
SPA132-06	6	132.0	137.5	3	2517	60	—	95	98	25	45	25	—
SPA140-06	6	140.0	145.5	3	2517	60	—	95	106	25	45	25	—
SPA150-06	6	150.0	155.5	3	2517	60	—	95	116	25	45	25	—
SPA160-06	6	160.0	165.5	3	2517	60	—	95	126	25	45	25	—
SPA180-06	6	180.0	185.5	3	3020	75	—	95	146	22	51	22	—
SPA200-06	6	200.0	205.5	3	3020	75	—	95	165	22	51	22	—
SPA224-06	6	224.0	229.5	3	3020	75	—	95	189	22	51	22	—
SPA250-06	6	250.0	255.5	6	3020	75	20	95	215	22	51	22	150
SPA280-06	6	280.0	285.5	6	3535	90	25	95	245	3	89	3	170
SPA315-06	6	315.0	320.5	6	3535	90	25	95	280	3	89	3	170
SPA355-06	6	355.0	360.5	5	3535	90	—	95	320	3	89	3	170
SPA400-06	6	400.0	405.5	5	3535	90	—	95	365	3	89	3	170
SPA450-06	6	450.0	455.5	5	3535	90	—	95	415	3	89	3	170
SPA500-06	6	500.0	505.5	5	3535	90	—	95	465	3	89	3	170
SPA560-06	6	560.0	565.5	5	3535	90	—	95	525	3	89	3	170
SPA630-06	6	630.0	635.5	4	4040	100	—	95	595	3.5	102	3.5	216
SPA800-06	6	800.0	805.5	4	4040	100	—	95	765	3.5	102	3.5	216
SPA1000-06	6	1000.0	1005.5	4	4545	110	—	95	965	9.5	114	9.5	225

Taper Bore V-pulleys

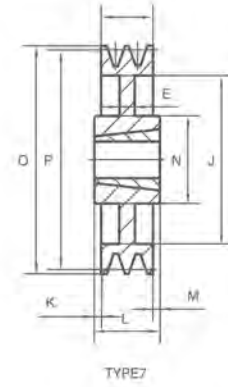
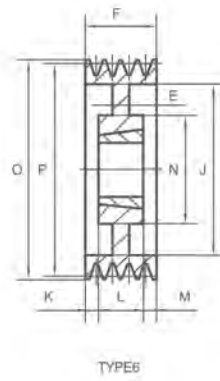
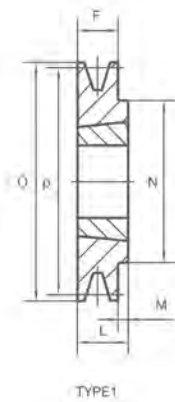

SPB-1

ITEM NO.	NO.OF GROOVES	P.D	O.D	TYPE	BUSH NO.	MAX BORE	E	F	J	K	L	M	N
SPB100-01	1	100.0	107.0	1	1610	42	—	25	—	—	25	—	—
SPB112-01	1	112.0	119.0	1	1610	42	—	25	—	—	25	—	—
SPB118-01	1	118.0	125.0	1	1610	42	—	25	—	—	25	—	—
SPB125-01	1	125.0	132.0	1	1610	42	—	25	—	—	25	—	—
SPB132-01	1	132.0	139.0	1	1610	42	—	25	—	—	25	—	—
SPB140-01	1	140.0	147.0	1	1610	42	—	25	—	—	25	—	—
SPB150-01	1	150.0	157.0	1	1610	42	—	25	—	—	25	—	—
SPB160-01	1	160.0	167.0	1	1610	42	—	25	—	—	25	—	—
SPB170-01	1	170.0	177.0	1	1610	42	—	25	—	—	25	—	—
SPB180-01	1	180.0	187.0	6	1610	42	10	25	137	—	25	—	80
SPB190-01	1	190.0	197.0	7	2012	50	10	25	147	3.5	32	3.5	100
SPB200-01	1	200.0	207.0	7	2012	50	10	25	157	3.5	32	3.5	100
SPB212-01	1	212.0	219.0	7	2012	50	10	25	169	3.5	32	3.5	100
SPB224-01	1	224.0	231.0	7	2012	50	10	25	181	3.5	32	3.5	100
SPB236-01	1	236.0	243.0	7	2012	50	10	25	193	3.5	32	3.5	100
SPB250-01	1	250.0	257.0	7	2012	50	10	25	207	3.5	32	3.5	100
SPB280-01	1	280.0	287.0	7	2012	50	10	25	237	3.5	32	3.5	100
SPB315-01	1	315.0	322.0	7	2012	50	10	25	272	3.5	32	3.5	100

Standard bore dimensions of taper bore bushes

Bushing	Stock Bores																						
	11	12	14	16	18	19	20	22	24	25	28	30	32	35	38	40	42	45	48	50	55	60	
1210	●	●	●	●	●	●	●	●	●	●	●	●	●										
1610			●	●	●	●	●	●	●	●	●	●	●	●	●	●	▲						
2012					●	●	●	●	●	●	●	●	●	●	●	●	●	●	●	●			
2517						●	●	●	●	●	●	●	●	●	●	●	●	●	●	●	●	●	●

▲ shallow keyway

Taper Bore V-pulleys

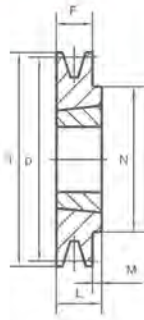

TYPE1

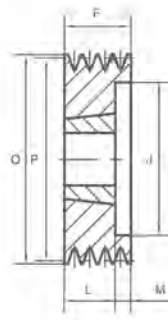

TYPE2

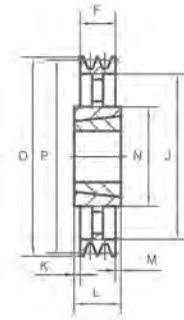

TYPE4

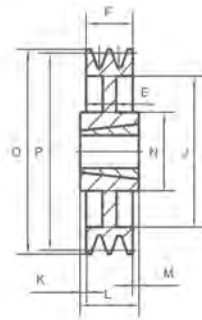

TYPE7

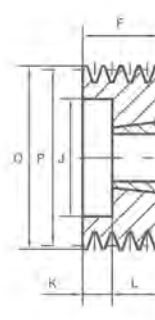

TYPE8

SPB-2

ITEM NO.	NO.OF GROOVES	PD	O.D	TYPE	BUSH NO.	MAX BORE	E	F	J	K	L	M	N
SPB100-02	2	100.0	107.0	8	1610	42	—	44	62	—	25	19	—
SPB112-02	2	112.0	119.0	2	1610	42	—	44	72	—	25	19	—
SPB118-02	2	118.0	127.0	2	1610	42	—	44	78	—	25	19	—
SPB125-02	2	125.0	132.0	2	2012	50	—	44	82	—	32	12	—
SPB132-02	2	132.0	139.0	2	2012	50	—	44	89	—	32	12	—
SPB140-02	2	140.0	147.0	2	2012	50	—	44	97	—	32	12	—
SPB150-02	2	150.0	157.0	2	2012	50	—	44	107	—	32	12	—
SPB160-02	2	160.0	167.0	2	2012	50	—	44	117	—	32	12	—
SPB170-02	2	170.0	177.0	2	2012	50	—	44	127	—	32	12	—
SPB180-02	2	180.0	187.0	1	2517	60	—	44	—	—	45	1	120
SPB190-02	2	190.0	197.0	1	2517	60	—	44	—	—	45	1	120
SPB200-02	2	200.0	207.0	1	2517	60	—	44	—	—	45	1	120
SPB212-02	2	212.0	219.0	7	2517	60	10	44	169	—	45	1	120
SPB224-02	2	224.0	231.0	7	2517	60	10	44	181	1	45	—	120
SPB236-02	2	236.0	243.0	7	2517	60	10	44	193	1	45	—	120
SPB250-02	2	250.0	257.0	7	2517	60	10	44	207	1	45	—	120
SPB280-02	2	280.0	287.0	7	2517	60	12	44	237	1	45	—	120
SPB300-02	2	300.0	307.0	7	2517	60	12	44	257	1	45	—	120
SPB315-02	2	315.0	322.0	7	2517	60	12	44	272	1	45	—	120
SPB335-02	2	335.0	342	7	2517	60	12	44	292	1	45	—	120
SPB355-02	2	355.0	362.0	4	3020	75	—	44	312	3.5	51	3.5	150
SPB400-02	2	400.0	407.0	4	3020	75	—	44	357	3.5	51	3.5	150
SPB450-02	2	450.0	457.0	4	3020	75	—	44	407	3.5	51	3.5	150
SPB500-02	2	500.0	507.0	4	3020	75	—	44	457	3.5	51	3.5	150
SPB560-02	2	560.0	567.0	4	3030	75	—	44	517	4	76	28	150
SPB630-02	2	630.0	637.0	4	3030	75	—	44	587	4	76	28	150

Taper Bore V-pulleys

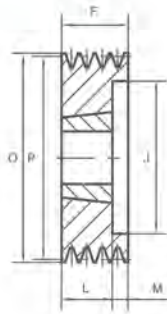

TYPE2

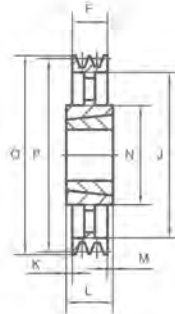

TYPE4

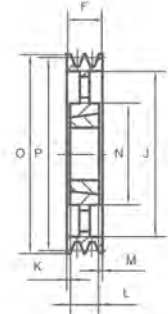

TYPE5

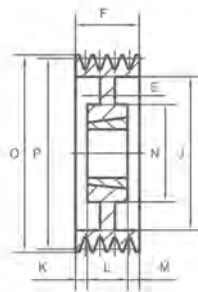

TYPE6

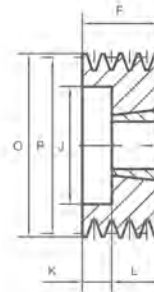

TYPE8

SPB-3

ITEM NO.	NO.OF GROOVES	PD	O.D	TYPE	BUSH NO.	MAX BORE	E	F	J	K	L	M	N
SPB100-03	3	100.0	107.0	8	1610	42	—	63	57	—	25	38	—
SPB112-03	3	112.0	119.0	2	1610	42	—	63	72	—	25	38	—
SPB118-03	3	118.0	125.0	2	1610	42	—	63	78	—	25	38	—
SPB125-03	3	125.0	132.0	2	2012	50	—	63	82	—	32	31	—
SPB132-03	3	132.0	139.0	2	2012	50	—	63	89	—	32	31	—
SPB140-03	3	140.0	147.0	2	2012	50	—	63	97	—	32	31	—
SPB150-03	3	150.0	157.0	2	2517	60	—	63	107	—	45	18	—
SPB160-03	3	160.0	167.0	2	2517	60	—	63	117	—	45	18	—
SPB170-03	3	170.0	177.0	2	2517	60	—	63	127	—	45	18	—
SPB180-03	3	180.0	187.0	2	2517	60	—	63	137	—	45	18	—
SPB190-03	3	190.0	197.0	2	2517	60	—	63	147	—	45	18	—
SPB200-03	3	200.0	207.0	2	2517	60	—	63	157	—	45	18	—
SPB212-03	3	212.0	219.0	6	2517	60	12	63	169	—	45	18	120
SPB224-03	3	224.0	231.0	6	2517	60	12	63	181	—	45	18	120
SPB236-03	3	236.0	243.0	6	2517	60	10	63	193	—	45	18	120
SPB250-03	3	250.0	257.0	6	3020	75	12	63	207	—	51	12	150
SPB280-03	3	280.0	287.0	6	3020	75	13	63	237	6	51	6	150
SPB300-03	3	300.0	307.0	6	3020	75	13	63	257	6	51	6	150
SPB315-03	3	315.0	322.0	6	3020	75	13	63	272	6	51	6	150
SPB335-03	3	335.0	342.0	6	3020	75	13	63	292	6	51	6	150
SPB355-03	3	355.0	362.0	5	3020	75	—	63	312	6	51	6	150
SPB400-03	3	400.0	407.0	4	3535	90	—	63	357	13	89	13	170
SPB450-03	3	450.0	457.0	4	3535	90	—	63	407	—	89	26	170
SPB500-03	3	500.0	507.0	4	3535	90	—	63	457	—	89	26	170
SPB560-03	3	560.0	567.0	4	3535	90	—	63	517	—	89	26	170
SPB630-03	3	630.0	637.0	4	3535	90	—	63	587	—	89	26	170
SPB710-03	3	710.0	717.0	4	3535	90	—	63	664	4	89	22	170
SPB800-03	3	800.0	807.0	4	3535	90	—	63	754	4	89	22	170
SPB900-03	3	900.0	907.0	4	3535	90	—	63	854	4	89	22	170
SPB1000-03	3	1000.0	1007.0	4	4040	100	—	63	954	6	102	33	200
SPB1250-03	3	1250.0	1257.0	4	4040	100	—	63	1204	6	102	33	200

Taper Bore V-pulleys

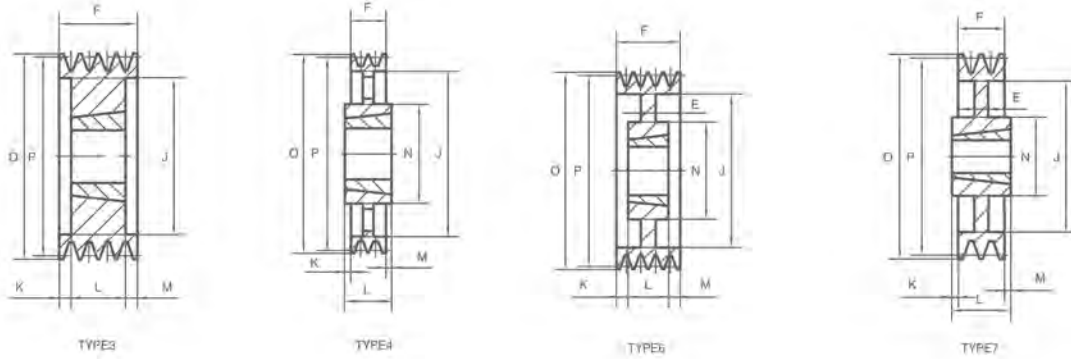

SPB-4

ITEM NO.	NO.OF GROOVES	PD	O.D	TYPE	BUSH NO.	MAX BORE	E	F	J	K	L	M	N
SPB125-04	4	125.0	132.0	3	2012	50	—	82	82	25	32	25	—
SPB132-04	4	132.0	139.0	3	2012	50	—	82	89	25	32	25	—
SPB140-04	4	140.0	147.0	3	2517	60	—	82	97	18.5	45	18.5	—
SPB150-04	4	150.0	157.0	3	2517	60	—	82	107	18.5	45	18.5	—
SPB160-04	4	160.0	167.0	3	2517	60	—	82	117	18.5	45	18.5	—
SPB170-04	4	170.0	177.0	3	2517	60	—	82	127	18.5	45	18.5	—
SPB180-04	4	180.0	187.0	3	2517	60	—	82	137	18.5	45	18.5	—
SPB190-04	4	190.0	197.0	3	2517	60	—	82	147	18.5	45	18.5	—
SPB200-04	4	200.0	207.0	3	3020	75	—	82	157	15.5	51	15.5	—
SPB212-04	4	212.0	219.0	3	3020	75	—	82	169	15.5	51	15.5	—
SPB224-04	4	224.0	231.0	3	3020	75	—	82	181	15.5	51	15.5	—
SPB236-04	4	236.0	243.0	3	3020	75	—	82	193	15.5	51	15.5	—
SPB250-04	4	250.0	257.0	6	3020	75	14	82	207	15.5	51	15.5	150
SPB280-04	4	280.0	287.0	6	3020	75	16	82	237	15.5	51	15.5	150
SPB300-04	4	300.0	307.0	6	3020	75	16	82	257	15.5	51	15.5	150
SPB315-04	4	315.0	322.0	7	3535	90	16	82	272	3.5	89	3.5	170
SPB335-04	4	335.0	342.0	7	3535	90	16	82	292	3.5	89	3.5	170
SPB355-04	4	355.0	362.0	7	3535	90	16	82	312	3.5	89	3.5	170
SPB400-04	4	400.0	407.0	4	3535	90	—	82	357	3.5	89	3.5	170
SPB450-04	4	450.0	457.0	4	3535	90	—	82	407	—	89	7	170
SPB500-04	4	500.0	507.0	4	3535	90	—	82	457	—	89	7	170
SPB560-04	4	560.0	567.0	4	3535	90	—	82	517	—	89	7	170
SPB630-04	4	630.0	637.0	4	3535	90	—	82	587	—	89	7	170
SPB710-04	4	710.0	717.0	4	3535	90	—	82	664	3.5	89	3.5	187
SPB800-04	4	800.0	807.0	4	4040	100	—	82	754	4	102	16	200
SPB900-04	4	900.0	907.0	4	4040	100	—	82	854	4	102	16	216
SPB1000-04	4	1000.0	1007.0	4	4040	100	—	82	954	4	102	16	216
SPB1250-04	4	1250.0	1257.0	4	4545	110	—	82	1204	6	114	26	225

Taper Bore V-pulleys

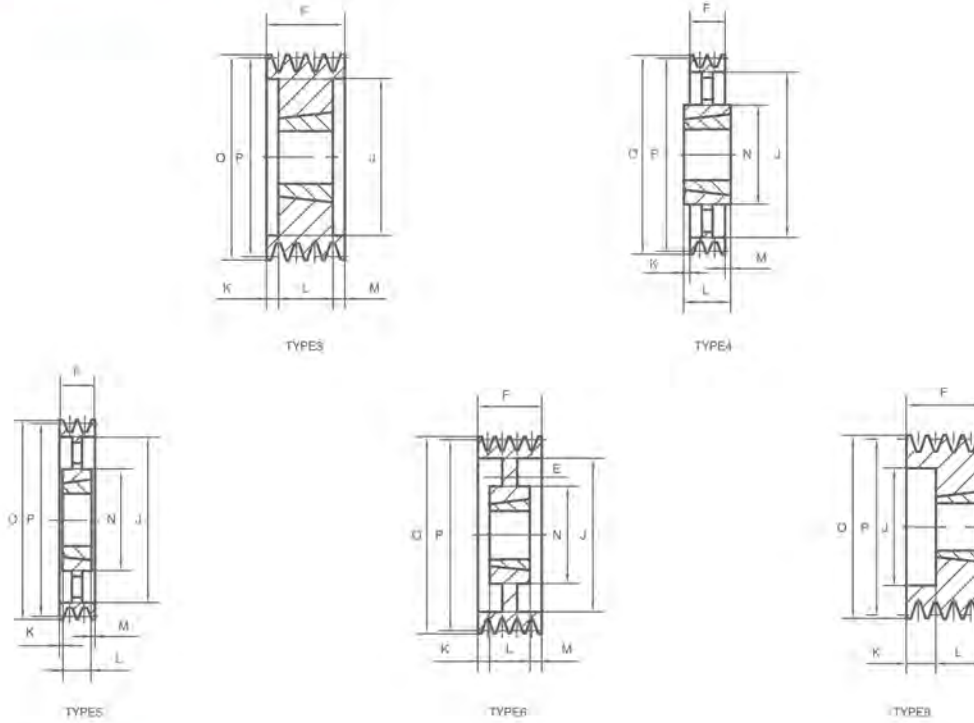

SPB-5

ITEM NO.	NO.OF GROOVES	PD	O.D	TYPE	BUSH NO.	MAX BORE	E	F	J	K	L	M	N
SPB125-05	5	125.0	132.0	8	2012	50	—	101	82	69	32	—	—
SPB132-05	5	132.0	139.0	8	2517	60	—	101	89	56	45	—	—
SPB140-05	5	140.0	147.0	3	2517	60	—	101	97	28	45	28	—
SPB150-05	5	150.0	157.0	3	2517	60	—	101	107	28	45	28	—
SPB160-05	5	160.0	167.0	3	2517	60	—	101	117	28	45	28	—
SPB170-05	5	170.0	177.0	3	3020	75	—	101	127	25	51	25	—
SPB180-05	5	180.0	187.0	3	3020	75	—	101	137	25	51	25	—
SPB190-05	5	190.0	197.0	3	3020	75	—	101	147	25	51	25	—
SPB200-05	5	200.0	207.0	3	3020	75	—	101	157	25	51	25	—
SPB212-05	5	212.0	219.0	3	3020	75	—	101	169	25	51	25	—
SPB224-05	5	224.0	231.0	3	3020	75	—	101	181	25	51	25	—
SPB236-05	5	236.0	243.0	3	3535	90	—	101	193	6	89	6	—
SPB250-05	5	250.0	257.0	3	3535	90	—	101	207	6	89	6	—
SPB280-05	5	280.0	287.0	6	3535	90	18	101	237	6	89	6	170
SPB300-05	5	300.0	307.0	6	3535	90	18	101	257	6	89	6	170
SPB315-05	5	315.0	322.0	6	3535	90	18	101	272	6	89	6	170
SPB335-05	5	335.0	342.0	6	3535	90	16	101	292	6	89	6	170
SPB355-05	5	355.0	362.0	5	3535	90	—	101	312	6	89	6	170
SPB400-05	5	400.0	407.0	5	3535	90	—	101	357	6	89	6	170
SPB450-05	5	450.0	457.0	5	3535	90	—	101	407	—	89	12	170
SPB500-05	5	500.0	507.0	5	3535	90	—	101	457	—	89	12	170
SPB560-05	5	560.0	567.0	4	4040	100	—	101	517	—	102	1	200
SPB630-05	5	630.0	637.0	4	4040	100	—	101	587	—	102	1	200
SPB710-05	5	710.0	717.0	4	4040	100	—	101	664	0.5	102	0.5	200
SPB800-05	5	800.0	807.0	4	4040	100	—	101	754	0.5	102	0.5	200
SPB900-05	5	900.0	907.0	4	4545	110	—	101	854	6.5	114	6.5	225
SPB1000-05	5	1000.0	1007.0	4	4545	110	—	101	954	6.5	114	6.5	225
SPB1250-05	5	1250.0	1257.0	4	4545	110	—	101	1204	6.5	114	6.5	225

Taper Bore V-pulleys

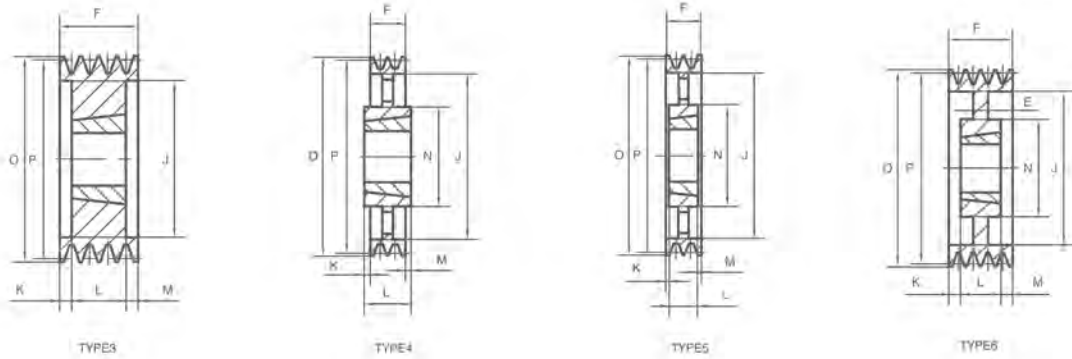

SPB-6

ITEM NO.	NO.OF GROOVES	P.D	O.D	TYPE	BUSH NO.	MAX BORE	E	F	J	K	L	M	N
SPB140-06	6	140.0	147.0	3	2517	60	—	120	97	37.5	45	37.5	—
SPB150-06	6	150.0	157.0	3	2517	60	—	120	107	37.5	45	37.5	—
SPB160-06	6	160.0	167.0	3	3020	75	—	120	117	34.5	51	34.5	—
SPB170-06	6	170.0	177.0	3	3020	75	—	120	127	34.5	51	34.5	—
SPB180-06	6	180.0	187.0	3	3020	75	—	120	137	34.5	51	34.5	—
SPB190-06	6	190.0	197.0	3	3020	75	—	120	147	34.5	51	34.5	—
SPB200-06	6	200.0	207.0	3	3020	75	—	120	157	34.5	51	34.5	—
SPB212-06	6	212.0	219.0	3	3535	90	—	120	169	15.5	89	15.5	—
SPB224-06	6	224.0	231.0	3	3535	90	—	120	181	15.5	89	15.5	—
SPB236-06	6	236.0	243.0	3	3535	90	—	120	193	15.5	89	15.5	—
SPB250-06	6	250.0	257.0	3	3535	90	—	120	207	15.5	89	15.5	—
SPB280-06	6	280.0	287.0	6	3535	90	18	120	237	15.5	89	15.5	170
SPB300-06	6	300.0	307.0	6	3535	90	18	120	257	15.5	89	15.5	170
SPB315-06	6	315.0	322.0	6	3535	90	18	120	272	15.5	89	15.5	170
SPB335-06	6	335.0	342.0	6	3535	90	18	120	292	15.5	89	15.5	170
SPB355-06	6	355.0	362.0	6	3535	90	18	120	312	15.5	89	15.5	170
SPB400-06	6	400.0	407.0	5	3535	90	—	120	357	15.5	89	15.5	170
SPB450-06	6	450.0	457.0	5	4040	100	—	120	407	—	102	18	200
SPB500-06	6	500.0	507.0	5	4040	100	—	120	457	—	102	18	200
SPB560-06	6	560.0	567.0	5	4040	100	—	120	517	—	102	18	200
SPB630-06	6	630.0	637.0	5	4040	100	—	120	587	—	102	18	200
SPB710-06	6	710.0	717.0	5	4040	100	—	120	664	9	102	9	216
SPB800-06	6	800.0	807.0	5	4545	110	—	120	754	3	114	3	225
SPB900-06	6	900.0	907.0	5	4545	110	—	120	854	3	114	3	225
SPB1000-06	6	1000.0	1007.0	5	4545	110	—	120	954	3	114	3	225
SPB1250-06	6	1250.0	1257.0	4	5050	125	—	120	1204	3.5	127	3.5	245

Taper Bore V-pulleys

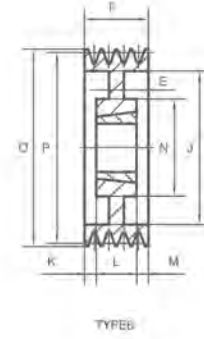
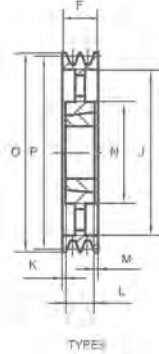
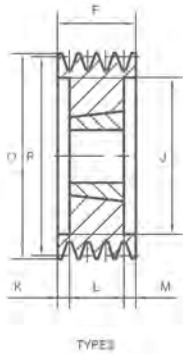

SPB-8

ITEM NO.	NO.OF GROOVES	PD	O.D	TYPE	BUSH NO.	MAX BORE	E	F	J	K	L	M	N
SPB160-08	8	160.0	167.0	3	3020	75	—	158	117	53.5	51	53.5	—
SPB170-08	8	170.0	177.0	3	3030	75	—	158	127	41	76	41	—
SPB180-08	8	180.0	187.0	3	3030	75	—	158	137	41	76	41	—
SPB190-08	8	190.0	197.0	3	3030	75	—	158	147	41	76	41	—
SPB200-08	8	200.0	207.0	3	3535	90	—	158	157	34.5	89	34.5	—
SPB212-08	8	212.0	219.0	3	3535	90	—	158	169	34.5	89	34.5	—
SPB224-08	8	224.0	231.0	3	3535	90	—	158	181	34.5	89	34.5	—
SPB236-08	8	236.0	243.0	3	3535	90	—	158	193	34.5	89	34.5	—
SPB250-08	8	250.0	257.0	3	3535	90	—	158	207	34.5	89	34.5	—
SPB280-08	8	280.0	287.0	3	3535	90	—	158	237	34.5	89	34.5	—
SPB300-08	8	300.0	307.0	6	3535	90	20	158	257	34.5	89	34.5	170
SPB315-08	8	315.0	322.0	6	3535	90	18	158	272	34.5	89	34.5	170
SPB335-08	8	335.0	342.0	6	3535	90	18	158	292	34.5	89	34.5	170
SPB355-08	8	355.0	362.0	6	3535	90	18	158	312	34.5	89	34.5	170
SPB400-08	8	400.0	407.0	5	4040	100	—	158	357	28	102	28	200
SPB450-08	8	450.0	457.0	5	4040	100	—	158	407	28	102	28	200
SPB500-08	8	500.0	507.0	5	4040	100	—	158	457	28	102	28	200
SPB560-08	8	560.0	567.0	5	4545	110	—	158	517	22	114	22	225
SPB630-08	8	630.0	637.0	5	4545	110	—	158	587	22	114	22	225
SPB710-08	8	710.0	717.0	5	4545	110	—	158	664	22	114	22	225
SPB800-08	8	800.0	807.0	5	4545	110	—	158	754	22	114	22	225
SPB900-08	8	900.0	907.0	5	4545	110	—	158	854	22	114	22	225
SPB1000-08	8	1000.0	1007.0	5	5050	125	—	158	954	15.5	127	15.5	245
SPB1250-08	8	1250.0	1257.0	5	5050	125	—	158	1204	15.5	127	15.5	245

Taper Bore V-pulleys

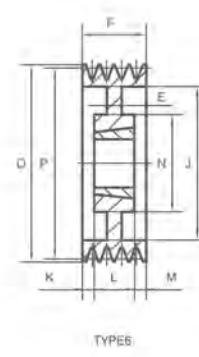
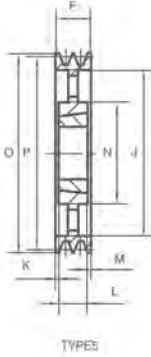
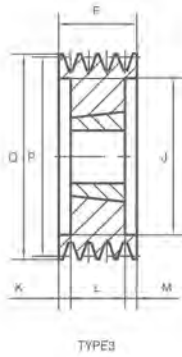

SPB-10

ITEM NO.	NO.OF GROOVES	P.D	O.D	TYPE	BUSH NO.	MAX BORE	E	F	J	K	L	M	N
SPB224-10	10	224.0	231.0	3	3535	90	—	196	181	53.5	89	53.5	—
SPB236-10	10	236.0	243.0	3	3535	90	—	196	193	53.5	89	53.5	—
SPB250-10	10	250.0	257.0	3	3535	90	—	196	207	53.5	89	53.5	—
SPB280-10	10	280.0	287.0	3	3535	90	—	196	237	53.5	89	53.5	—
SPB315-10	10	315.0	322.0	6	3535	90	18	196	272	53.5	89	53.5	170
SPB335-10	10	335.0	342.0	6	4040	100	20	196	292	47	102	47	200
SPB355-10	10	355.0	362.0	6	4040	100	20	196	312	47	102	47	200
SPB400-10	10	400.0	407.0	5	4040	100	—	196	357	47	102	47	200
SPB450-10	10	450.0	457.0	5	4545	110	—	196	407	41	114	41	225
SPB500-10	10	500.0	507.0	5	4545	110	—	196	457	41	114	41	225
SPB560-10	10	560.0	567.0	5	4545	110	—	196	517	41	114	41	225
SPB630-10	10	630.0	637.0	5	4545	110	—	196	587	41	114	41	225
SPB710-10	10	710.0	717.0	5	4545	110	—	196	664	41	114	41	225
SPB800-10	10	800.0	807.0	5	4545	110	—	196	754	41	114	41	225
SPB900-10	10	900.0	907.0	5	5050	125	—	196	854	34.5	127	34.5	245
SPB1000-10	10	1000.0	1007.0	5	5050	125	—	196	954	34.5	127	34.5	245

Standard bore dimensions of taper bore bushes

Bushing	Stock Bores																									
	25	28	30	32	35	38	40	42	45	48	50	55	60	65	70	75	80	85	90	95	100	105	115	120	125	
3030	●	●	●	●	●	●	●	●	●	●	●	●	●	●	●											
3535					●	●	●	●	●	●	●	●	●	●	●	●	●	●	●							
4040							●	●	●	●	●	●	●	●	●	●	●	●	●	●	●					
4045											●	●	●	●	●	●	●	●	●	●	●	●				
5050												●	●	●	●	●	●	●	●	●	●	●	●	●	●	●

Taper Bore V-pulleys

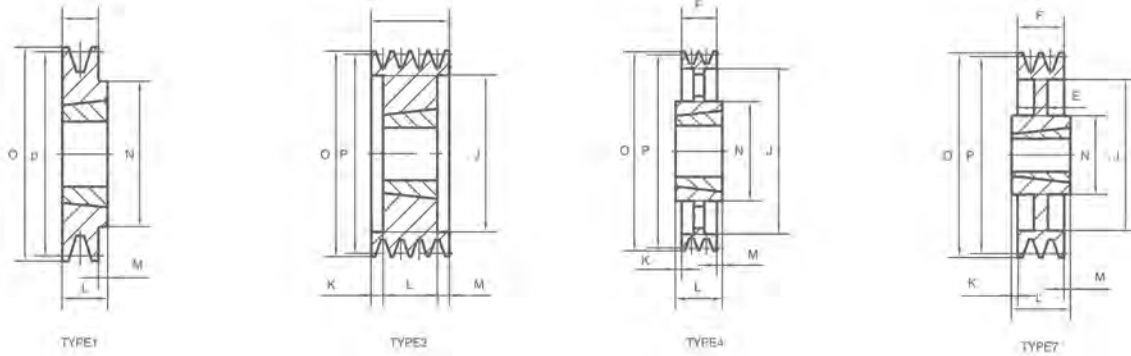

SPC-3

ITEM NO.	NO.OF GROOVES	PD	O.D	TYPE	BUSH NO.	MAX BORE	E	F	J	K	L	M	N
SPC200-03	3	200.0	209.6	3	2517	60	—	85	150	20	45	20	—
SPC212-03	3	212.0	221.6	3	3020	75	—	85	162	17	51	17	—
SPC224-03	3	224.0	233.6	3	3020	75	—	85	173	17	51	17	—
SPC236-03	3	236.0	245.6	3	3020	75	—	85	185	17	51	17	—
SPC250-03	3	250.0	259.6	3	3020	75	—	85	200	17	51	17	—
SPC265-03	3	265.0	274.6	1	3535	90	—	85	209	—	89	4	170
SPC280-03	3	280.0	289.6	1	3535	90	—	85	224	—	89	4	170
SPC300-03	3	300.0	309.6	7	3535	90	18	85	249	2	89	2	170
SPC315-03	3	315.0	324.6	7	3535	90	18	85	264	2	89	2	170
SPC335-03	3	335.0	345.0	7	3535	90	18	85	284	2	89	2	170
SPC355-03	3	355.0	365.0	7	3535	90	18	85	304	2	89	2	170
SPC375-03	3	375.0	384.6	7	3535	90	20	85	324	2	89	2	170
SPC400-03	3	400.0	409.6	4	3535	90	—	85	344	2	89	2	170
SPC425-03	3	425.0	434.6	4	3535	90	—	85	369	2	89	2	170
SPC450-03	3	450.0	459.6	4	3535	90	—	85	394	2	89	2	170
SPC475-03	3	475.0	484.6	4	3535	90	—	85	419	2	89	2	170
SPC500-03	3	500.0	509.6	4	3535	90	—	85	444	2	89	2	170
SPC530-03	3	530.0	539.6	4	3535	90	—	85	474	2	89	2	170
SPC560-03	3	560.0	569.6	4	3535	90	—	85	504	2	89	2	170
SPC630-03	3	630.0	639.6	4	4040	100	—	85	574	8.5	102	8.5	200
SPC800-03	3	800.0	809.6	4	4545	110	—	85	737	4	114	25	225
SPC1000-03	3	1000.0	1009.6	4	5050	125	—	85	937	8	127	34	245
SPC1250-03	3	1250.0	1259.6	4	5050	125	—	85	1187	8	127	34	245

Taper Bore V-pulleys

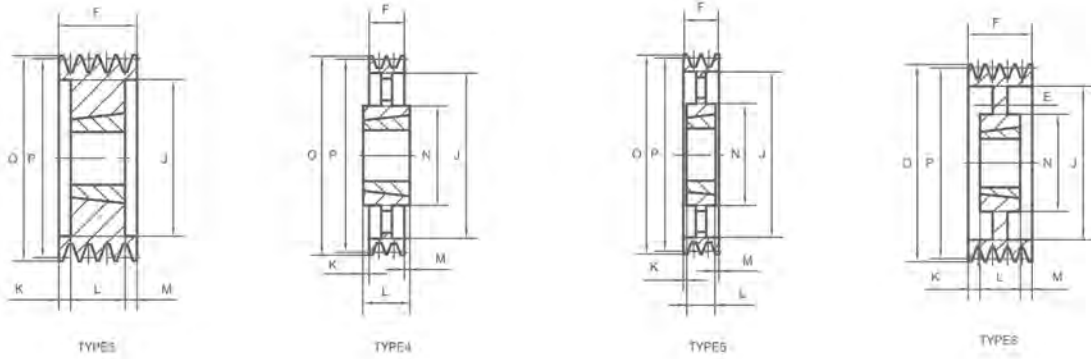

SPC-4

ITEM NO.	NO.OF GROOVES	P.D	O.D	TYPE	BUSH NO.	MAX BORE	E	F	J	K	L	M	N
SPC200-04	4	200.0	209.6	3	3020	75	—	111	144	30	51	30	—
SPC212-04	4	212.0	221.6	3	3020	75	—	111	156	30	51	30	—
SPC224-04	4	224.0	233.6	3	3535	90	—	111	168	11	89	11	—
SPC236-04	4	236.0	245.6	3	3535	90	—	111	180	11	89	11	—
SPC250-04	4	250.0	259.6	3	3535	90	—	111	194	11	89	11	—
SPC265-04	4	265.0	274.6	3	3535	90	—	111	209	11	89	11	—
SPC280-04	4	280.0	289.6	3	3535	90	—	111	224	11	89	11	—
SPC300-04	4	300.0	309.6	6	3535	90	20	111	244	11	89	11	170
SPC315-04	4	315.0	324.6	6	3535	90	20	111	259	11	89	11	170
SPC335-04	4	335.0	344.6	6	3535	90	20	111	279	11	89	11	170
SPC355-04	4	355.0	365.0	6	3535	90	20	111	299	11	89	11	170
SPC375-04	4	375.0	384.6	6	3535	90	25	111	319	11	89	11	170
SPC400-04	4	400.0	409.6	5	3535	90	—	111	344	11	89	11	170
SPC425-04	4	425.0	434.6	5	3535	90	—	111	369	11	89	11	170
SPC450-04	4	450.0	459.6	5	3535	90	—	111	394	11	89	11	170
SPC475-04	4	475.0	484.6	5	3535	90	—	111	419	11	89	11	170
SPC500-04	4	500.0	509.6	5	3535	90	—	111	444	11	89	11	170
SPC530-04	4	530.0	539.6	5	3535	90	—	111	474	11	89	11	170
SPC560-04	4	560.0	569.6	5	4040	100	—	111	504	4.5	102	4.5	200
SPC630-04	4	630.0	639.6	4	4545	110	—	111	574	1.5	114	1.5	225
SPC800-04	4	800.0	809.6	4	5050	125	—	111	737	4	127	12	245
SPC1000-04	4	1000.0	1009.6	4	5050	125	—	111	937	1	127	12	245
SPC1250-04	4	1250.0	1259.6	4	5050	125	—	111	1187	4	127	12	245

Taper Bore V-pulleys

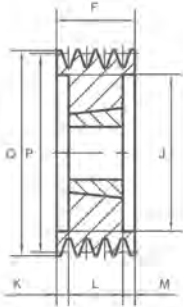

TYPE3

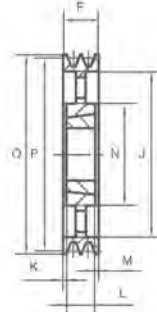

TYPE5

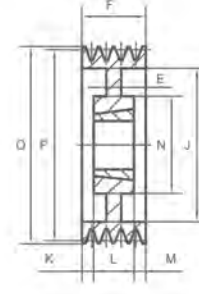

TYPE6

SPC-5

ITEM NO.	NO.OF GROOVES	PD	O.D	TYPE	BUSH NO.	MAX BORE	E	F	J	K	L	M	N
SPC200-05	5	200.0	209.6	3	3535	90	—	136	150	23.5	89	23.5	—
SPC212-05	5	212.0	221.6	3	3535	90	—	136	160	23.5	89	23.5	—
SPC224-05	5	224.0	233.6	3	3535	90	—	136	173	23.5	89	23.5	—
SPC236-05	5	236.0	245.6	3	3535	90	—	136	185	23.5	89	23.5	—
SPC250-05	5	250.0	259.6	3	3535	90	—	136	198	23.5	89	23.5	—
SPC265-05	5	265.0	274.6	3	3535	90	—	136	213	23.5	89	23.5	—
SPC280-05	5	280.0	289.6	3	3535	90	—	136	228	23.5	89	23.5	—
SPC300-05	5	300.0	309.6	6	3535	90	20	136	247	23.5	89	23.5	170
SPC315-05	5	315.0	324.6	6	3535	90	20	136	264	23.5	89	23.5	170
SPC335-05	5	335.0	344.6	6	3535	90	20	136	280	23.5	89	23.5	170
SPC355-05	5	355.0	364.6	6	3535	90	20	136	304	23.5	89	23.5	170
SPC375-05	5	375.0	384.6	6	3535	90	20	136	324	23.5	89	23.5	170
SPC400-05	5	400.0	409.6	5	3535	90	—	136	344	23.5	89	23.5	170
SPC425-05	5	425.0	434.6	5	4040	100	—	136	369	17	102	17	200
SPC450-05	5	450.0	459.6	5	4040	100	—	136	394	17	102	17	200
SPC475-05	5	475.0	484.6	5	4040	100	—	136	419	17	102	17	200
SPC500-05	5	500.0	509.6	5	4040	100	—	136	444	17	102	14	200
SPC530-05	5	530.0	539.6	5	4040	100	—	136	474	17	102	17	200
SPC560-05	5	560.0	569.6	5	4545	110	—	136	504	11	114	11	225
SPC630-05	5	630.0	639.6	5	5050	125	—	136	574	4.5	127	4.5	245
SPC710-05	5	710.0	719.6	5	5050	125	—	136	654	4.5	127	4.5	245
SPC800-05	5	800.0	809.6	5	5050	125	—	136	737	4.5	127	4.5	245
SPC1000-05	5	1000.0	1009.6	5	5050	125	—	136	937	4.5	127	4.5	245
SPC1250-05	5	1250.0	1259.6	5	5050	125	—	136	1187	4.5	127	4.5	245

Taper Bore V-pulleys

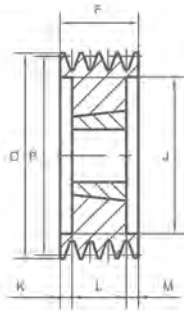

TYPE3

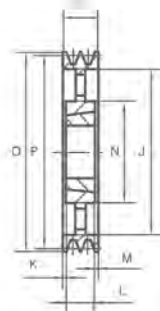

TYPE5

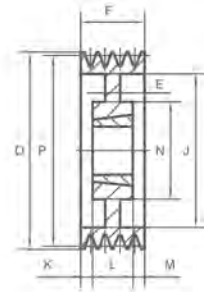

TYPE6

SPC-6

ITEM NO.	NO.OF GROOVES	P.D	O.D	TYPE	BUSH NO.	MAX BORE	E	F	J	K	L	M	N
SPC200-06	6	200.0	209.6	3	3535	90	—	162	148	36.5	89	36.5	—
SPC212-06	6	212.0	221.6	3	3535	90	—	162	160	36.5	89	36.5	—
SPC224-06	6	224.0	233.6	3	3535	90	—	162	173	36.5	89	36.5	—
SPC236-06	6	236.0	245.6	3	3535	90	—	162	185	36.5	89	36.5	—
SPC250-06	6	250.0	259.6	3	3535	90	—	162	198	36.5	89	36.5	—
SPC265-06	6	265.0	274.6	3	3535	90	—	162	213	36.5	89	36.5	—
SPC280-06	6	280.0	289.6	3	3535	90	—	162	228	36.5	89	36.5	—
SPC300-06	6	300.0	309.6	6	3535	90	20	162	247	36.5	89	36.5	170
SPC315-06	6	315.0	324.6	6	3535	90	20	162	264	36.5	89	36.5	170
SPC335-06	6	335.0	344.6	6	3535	90	20	162	280	36.5	89	36.5	170
SPC355-06	6	355.0	364.6	6	3535	90	20	162	304	36.5	89	36.5	170
SPC375-06	6	375.0	384.6	6	4040	100	20	162	324	30	102	30	200
SPC400-06	6	400.0	409.6	6	4040	100	20	162	348	30	102	30	200
SPC425-06	6	425.0	434.6	6	4545	110	30	162	369	24	114	24	225
SPC450-06	6	450.0	459.6	6	4545	110	30	162	394	24	114	24	225
SPC475-06	6	475.0	484.6	6	4545	110	30	162	419	24	114	24	225
SPC500-06	6	500.0	509.6	5	4545	110	30	162	444	24	114	24	225
SPC530-06	6	530.0	539.6	5	4545	110	30	162	474	24	114	24	225
SPC560-06	6	560.0	569.6	5	5050	125	—	162	504	17.5	127	17.5	245
SPC630-06	6	630.0	639.6	5	5050	125	—	162	574	17.5	127	17.5	245
SPC710-06	6	710.0	719.6	5	5050	125	—	162	656	17.5	127	17.5	245
SPC800-06	6	800.0	809.6	5	5050	125	—	162	737	17.5	127	17.5	245
SPC1000-06	6	1000.0	1009.6	5	5050	125	—	162	937	17.5	127	17.5	245
SPC1250-06	6	1250.0	1259.6	5	5050	125	—	162	1187	17.5	127	17.5	245

Taper Bore V-pulleys

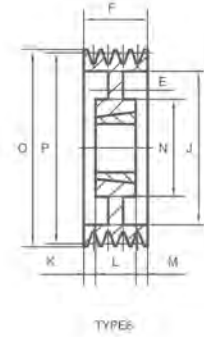
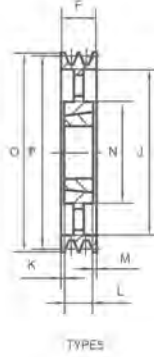
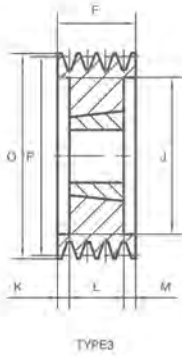

SPC-8

ITEM NO.	NO.OF GROOVES	PD	O.D	TYPE	BUSH NO.	MAX BORE	E	F	J	K	L	M	N
SPC200-08	8	200.0	209.6	3	3535	90	—	213	148	62	89	62	—
SPC212-08	8	212.0	221.6	3	3535	90	—	213	160	62	89	62	—
SPC224-08	8	224.0	233.6	3	3535	90	—	213	170	62	89	62	—
SPC236-08	8	236.0	245.6	3	3535	90	—	213	184	62	89	62	—
SPC250-08	8	250.0	259.6	3	3535	90	—	213	198	62	89	62	—
SPC265-08	8	265.0	274.6	3	3535	90	—	213	213	62	89	62	—
SPC280-08	8	280.0	289.6	3	3535	90	—	213	228	62	89	62	—
SPC300-08	8	300.0	309.6	3	4040	100	—	213	247	55.5	102	55.5	—
SPC315-08	8	315.0	324.6	3	4040	100	—	213	258	55.5	102	55.5	—
SPC335-08	8	335.0	344.6	6	4040	100	—	213	280	55.5	102	55.5	—
SPC355-08	8	355.0	364.6	3	4040	100	—	213	304	55.5	102	55.5	—
SPC375-08	8	375.0	384.6	3	4545	110	—	213	324	49.5	114	49.5	—
SPC400-08	8	400.0	409.6	6	4545	110	20	213	348	49.5	114	49.5	220
SPC425-08	8	425.0	434.6	6	5050	125	30	213	369	43	127	43	245
SPC450-08	8	450.0	459.6	6	5050	125	30	213	394	43	127	43	245
SPC475-08	8	475.0	484.6	6	5050	125	30	213	419	43	127	43	245
SPC500-08	8	500.0	509.6	6	5050	125	30	213	444	43	127	43	245
SPC530-08	8	530.0	539.6	6	5050	125	30	213	474	43	127	43	245
SPC560-08	8	560.0	569.6	5	5050	125	—	213	504	43	127	43	245
SPC630-08	8	630.0	639.6	5	5050	125	—	213	574	43	127	43	245
SPC710-08	8	710.0	719.6	5	5050	125	—	213	656	43	127	43	245
SPC800-08	8	800.0	809.6	5	5050	125	—	213	737	43	127	43	245
SPC1000-08	8	1000.0	1009.6	5	5050	125	—	213	937	43	127	43	245
SPC1250-08	8	1250.0	1259.6	5	5050	125	—	213	1187	43	127	43	245

Taper Bore V-pulleys

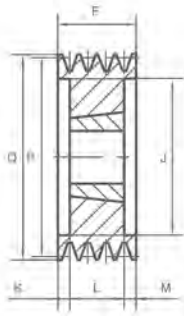

TYPE E3

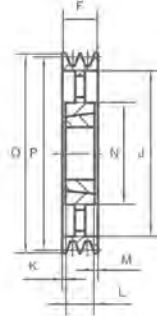

TYPE E5

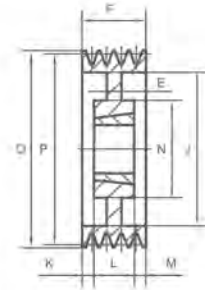

TYPE E6

SPC-10

ITEM NO.	NO.OF GROOVES	PD	O.D	TYPE	BUSH NO.	MAX BORE	E	F	J	K	L	M	N
SPC250-10	10	250.0	259.6	3	4040	100	—	264	196	81	102	84	—
SPC280-10	10	280.0	289.6	3	4040	100	—	264	226	81	102	81	—
SPC300-10	10	300.0	309.6	3	4545	110	—	264	245	75	114	75	—
SPC315-10	10	315.0	324.6	3	4545	110	—	264	258	75	114	75	—
SPC355-10	10	355.0	364.6	3	4545	110	—	264	299	75	114	75	—
SPC400-10	10	400.0	409.6	3	5050	125	—	264	342	68.5	127	68.5	—
SPC450-10	10	450.0	459.6	6	5050	125	40	264	394	68.5	127	68.5	245
SPC500-10	10	500.0	509.6	6	5050	125	40	264	444	68.5	127	68.5	245
SPC560-10	10	560.0	569.6	5	5050	125	—	264	504	68.5	127	68.5	245
SPC630-10	10	630.0	639.6	5	5050	125	—	264	574	68.5	127	68.5	245
SPC710-10	10	710.0	719.6	5	5050	125	—	264	656	68.5	127	68.5	245
SPC800-10	10	800.0	809.6	5	5050	125	—	264	737	68.5	127	68.5	245
SPC1000-10	10	1000.0	1009.6	5	5050	125	—	264	937	68.5	127	68.5	245
SPC1250-10	10	1250.0	1259.6	5	5050	125	—	264	1187	68.5	127	68.5	245

Stock Bore V-pulleys

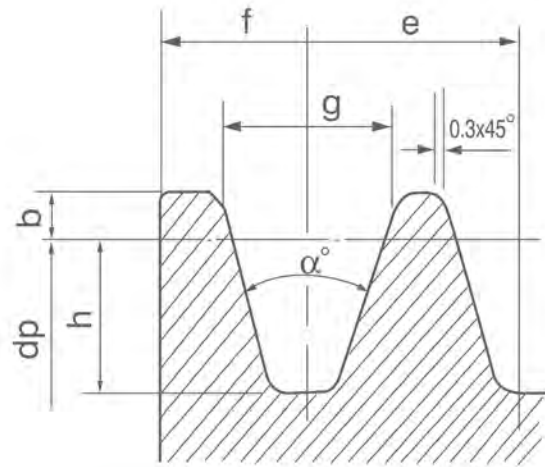

SPZ - SPA - SPB - SPC BS3790 - 1981

SIZE	PD(mm)	α°	f	e	g	h	b
Z-SPZ	≤80	34	8	12	9.7	9	2
	>80	38			9.9		
A-SPA	≤118	34	10	15	12.7	11	2.75
	>118	38			12.9		
B-SPB	≤190	34	12.5	19	16.1	14	3.5
	>190	38			16.4		
C-SPC	≤315	34	17	25.5	21.9	19	4.8
	>315	38			22.3		

SELECTION FOR STOCK V-BELT PULLEYS

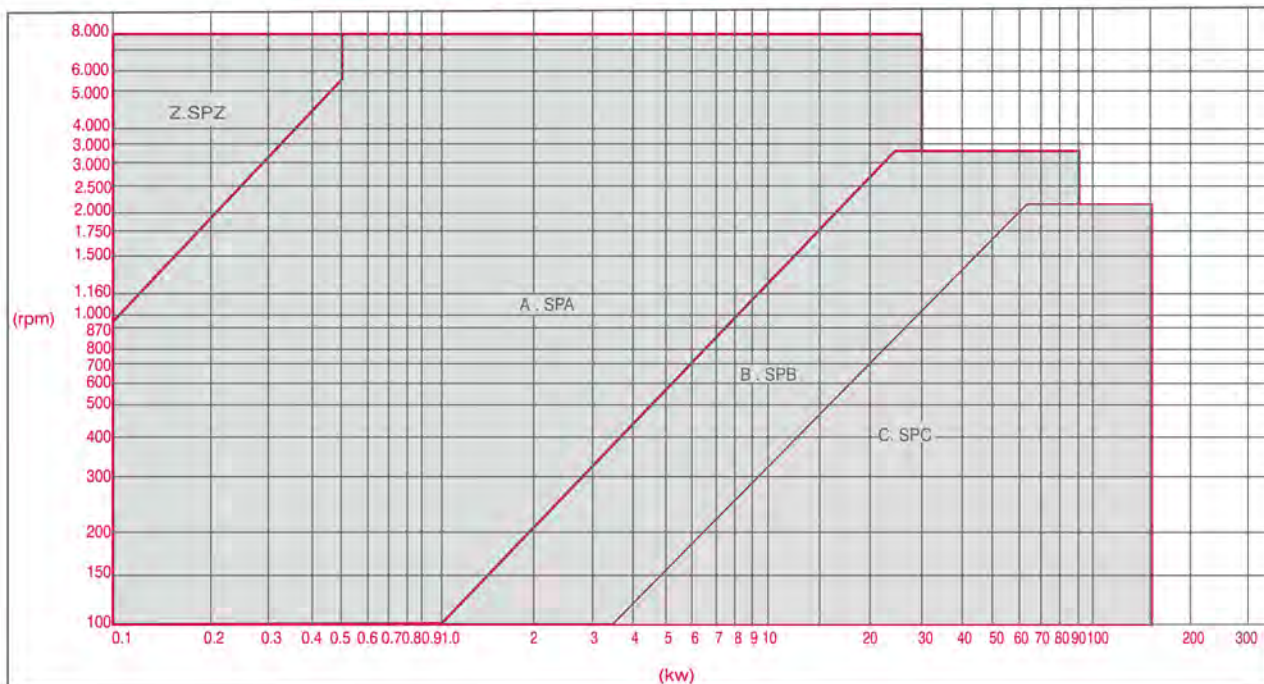

Stock Bore V-pulleys

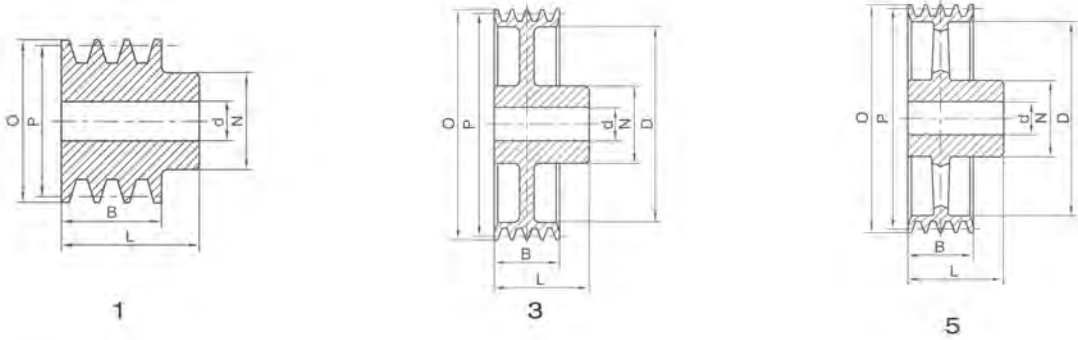

SPZ-1

ITEM NO.	NO.OF GROOVES	O.D	P.D	TYPE	N	L	D	E	B	d
SPZ50-1S	1	54	50	1	40	28	—	—	16	10
SPZ56-1S	1	60	56	1	45	28	—	—	16	10
SPZ63-1S	1	67	63	1	50	28	—	—	16	10
SPZ71-1S	1	75	71	1	50	28	—	—	16	10
SPZ75-1S	1	79	75	1	50	28	—	—	16	10
SPZ80-1S	1	84	80	1	50	28	—	—	16	10
SPZ85-1S	1	89	85	1	50	28	—	—	16	10
SPZ90-1S	1	94	90	1	50	28	—	—	16	10
SPZ95-1S	1	99	95	1	50	28	—	—	16	10
SPZ100-1S	1	104	100	1	50	28	—	—	16	10
SPZ106-1S	1	110	106	1	50	28	—	—	16	10
SPZ112-1S	1	116	112	1	50	28	—	—	16	10
SPZ118-1S	1	122	118	3	50	28	93	8	16	10
SPZ125-1S	1	129	125	3	50	28	100	8	16	15
SPZ132-1S	1	136	132	3	50	28	106	8	16	15
SPZ140-1S	1	144	140	3	50	28	114	8	16	15
SPZ150-1S	1	154	150	3	50	28	124	8	16	15
SPZ160-1S	1	164	160	3	55	32	134	8	16	15
SPZ180-1S	1	184	180	5	55	32	154	8	16	20
SPZ200-1S	1	204	200	5	55	32	174	8	16	20
SPZ224-1S	1	228	224	5	55	32	198	8	16	20
SPZ250-1S	1	254	250	5	55	32	224	8	16	20

Stock Bore V-pulleys

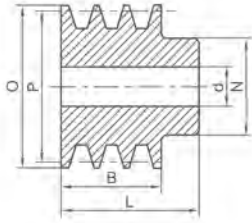

1

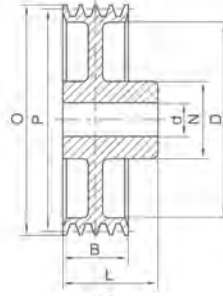

3

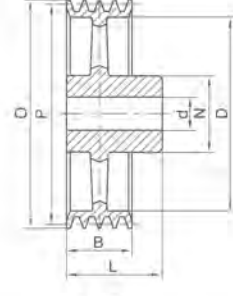

5

SPZ-2

ITEM NO.	NO.OF GROOVES	O.D	P.D	TYPE	N	L	D	E	B	d
SPZ50-2S	2	54	50	1	40	35	—	—	28	10
SPZ56-2S	2	60	56	1	45	35	—	—	28	10
SPZ63-2S	2	67	63	1	50	35	—	—	28	10
SPZ71-2S	2	75	71	1	55	35	—	—	28	10
SPZ75-2S	2	79	75	1	60	35	—	—	28	10
SPZ80-2S	2	84	80	1	60	35	—	—	28	10
SPZ85-2S	2	89	85	1	60	35	—	—	28	10
SPZ90-2S	2	94	90	1	60	35	—	—	28	10
SPZ95-2S	2	99	95	1	60	35	—	—	28	15
SPZ100-2S	2	104	100	1	60	35	—	—	28	15
SPZ106-2S	2	110	106	1	60	35	—	—	28	15
SPZ112-2S	2	116	112	1	60	35	—	—	28	15
SPZ118-2S	2	122	118	3	60	35	97	8	28	15
SPZ125-2S	2	129	125	3	60	35	99	8	28	15
SPZ132-2S	2	136	132	3	60	40	105	8	28	15
SPZ140-2S	2	144	140	3	60	40	114	8	28	15
SPZ150-2S	2	154	150	3	60	40	124	8	28	15
SPZ160-2S	2	164	160	3	60	40	134	8	28	15
SPZ180-2S	2	184	180	5	60	40	154	8	28	20
SPZ200-2S	2	204	200	5	60	40	174	8	28	20
SPZ224-2S	2	228	224	5	60	40	198	8	28	20
SPZ250-2S	2	254	250	5	60	40	224	10	28	20
SPZ280-2S	2	284	280	5	65	45	254	10	28	20
SPZ315-2S	2	319	315	5	65	45	289	10	28	20

Stock Bore V-pulleys

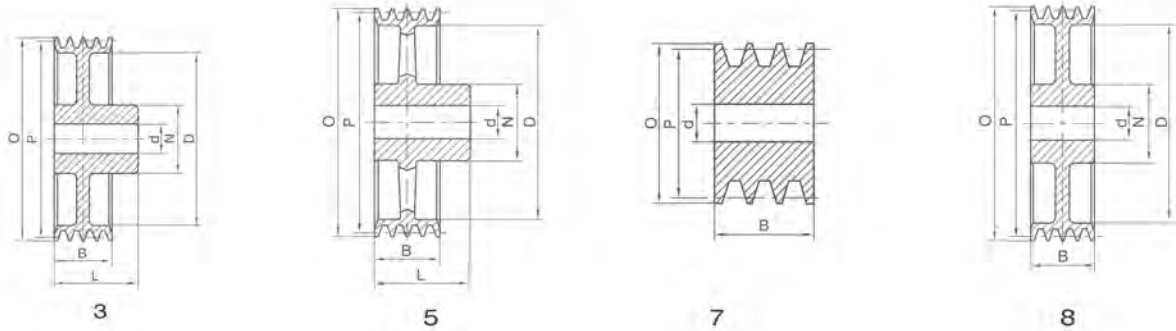

SPZ-3

ITEM NO.	NO.OF GROOVES	O.D	PD	TYPE	N	L	D	E	B	d
SPZ50-3S	3	54	50	7	—	—	—	—	40	10
SPZ56-3S	3	60	56	7	—	—	—	—	40	10
SPZ63-3S	3	67	63	7	—	—	—	—	40	10
SPZ71-3S	3	75	71	7	—	—	—	—	40	10
SPZ75-3S	3	79	75	7	—	—	—	—	40	10
SPZ80-3S	3	84	80	7	—	—	—	—	40	10
SPZ85-3S	3	89	85	7	—	—	—	—	40	15
SPZ90-3S	3	94	90	7	—	—	—	—	40	15
SPZ95-3S	3	99	95	7	—	—	—	—	40	15
SPZ100-3S	3	104	100	7	—	—	—	—	40	15
SPZ106-3S	3	110	106	7	—	—	—	—	40	15
SPZ112-3S	3	116	112	7	—	—	—	—	40	15
SPZ118-3S	3	122	118	7	—	—	—	—	40	15
SPZ125-3S	3	129	125	7	—	—	—	—	40	15
SPZ132-3S	3	136	132	8	60	40	106	8	40	15
SPZ140-3S	3	144	140	8	60	40	114	8	40	15
SPZ150-3S	3	154	150	8	60	40	124	8	40	20
SPZ160-3S	3	164	160	3	65	45	134	8	40	20
SPZ180-3S	3	184	180	5	65	45	154	8	40	20
SPZ200-3S	3	204	200	5	65	45	174	10	40	20
SPZ224-3S	3	228	224	5	65	45	198	10	40	20
SPZ250-3S	3	254	250	5	65	45	224	12	40	20

Stock Bore V-pulleys

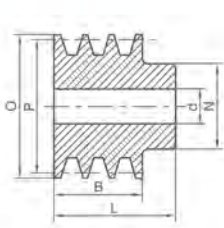

1

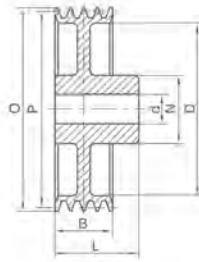

3

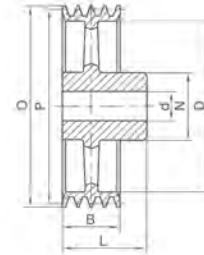

5

SPA-1

ITEM NO.	NO.OF GROOVES	O.D	P.D	TYPE	N	L	D	E	B	d
SPA40-1S	1	45.5	40	1	40	35	—	—	20	10
SPA50-1S	1	55.5	50	1	40	35	—	—	20	10
SPA60-1S	1	65.5	60	1	40	35	—	—	20	10
SPA71-1S	1	76.5	71	1	40	40	—	—	20	10
SPA75-1S	1	80.5	75	1	40	40	—	—	20	10
SPA80-1S	1	85.5	80	1	45	40	—	—	20	10
SPA85-1S	1	90.5	85	1	45	40	—	—	20	10
SPA90-1S	1	95.5	90	1	45	40	—	—	20	10
SPA95-1S	1	100.5	95	1	45	40	—	—	20	10
SPA100-1S	1	105.5	100	1	48	40	—	—	20	10
SPA106-1S	1	111.5	106	1	48	40	—	—	20	10
SPA112-1S	1	117.5	112	1	48	40	—	—	20	10
SPA118-1S	1	123.5	118	1	60	40	—	—	20	15
SPA132-1S	1	137.5	132	1	60	40	—	—	20	15
SPA140-1S	1	145.5	140	3	60	40	107	10	20	15
SPA150-1S	1	155.5	150	3	60	40	117	10	20	15
SPA160-1S	1	165.5	160	3	60	40	127	10	20	15
SPA170-1S	1	175.5	170	3	60	40	137	10	20	15
SPA180-1S	1	185.5	180	3	65	40	147	10	20	20
SPA200-1S	1	205.5	200	3	65	45	167	10	20	20
SPA224-1S	1	229.5	224	3	65	45	192	10	20	20
SPA250-1S	1	255.5	250	3	75	50	217	12	20	20
SPA280-1S	1	285.5	280	5	75	50	247	14	20	20
SPA300-1S	1	305.5	300	5	75	50	267	14	20	20
SPA315-1S	1	320.5	315	5	75	60	282	14	20	20
SPA355-1S	1	360.5	355	5	75	50	322	14	20	20
SPA400-1S	1	405.5	400	5	90	50	367	14	20	20
SPA450-1S	1	455.5	450	5	90	50	417	14	20	20

Stock Bore V-pulleys

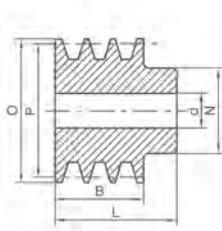

1

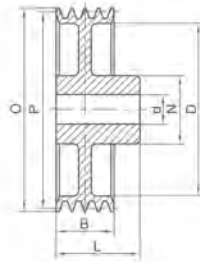

3

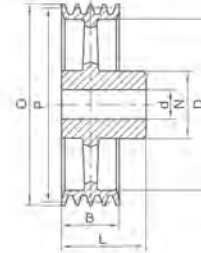

5

SPA-2

ITEM NO.	NO.OF GROOVES	O.D	PD	TYPE	N	L	D	E	B	d
SPA50-2S	2	55.5	50	1	40	45	—	—	35	10
SPA60-2S	2	65.5	60	1	40	45	—	—	35	10
SPA71-2S	2	76.5	71	1	50	45	—	—	35	10
SPA75-2S	2	80.5	75	1	50	45	—	—	35	10
SPA80-2S	2	85.5	80	1	50	45	—	—	35	10
SPA85-2S	2	90.5	85	1	50	45	—	—	35	10
SPA90-2S	2	95.5	90	1	60	45	—	—	35	15
SPA95-2S	2	100.5	95	1	60	45	—	—	35	15
SPA100-2S	2	105.5	100	1	60	45	—	—	35	15
SPA106-2S	2	111.5	106	1	60	45	—	—	35	15
SPA112-2S	2	117.5	112	1	60	45	—	—	35	15
SPA118-2S	2	123.5	118	1	60	45	—	—	35	15
SPA132-2S	2	137.5	132	1	60	45	—	—	35	15
SPA140-2S	2	145.5	140	3	60	45	107	10	35	15
SPA150-2S	2	155.5	150	3	60	45	117	10	35	15
SPA160-2S	2	165.5	160	3	60	45	127	10	35	15
SPA170-2S	2	175.5	170	3	60	45	137	10	35	15
SPA180-2S	2	185.5	180	3	70	50	147	12	35	20
SPA200-2S	2	205.5	200	3	70	50	167	12	35	20
SPA224-2S	2	229.5	224	3	70	50	192	12	35	20
SPA250-2S	2	255.5	250	3	75	50	217	12	35	20
SPA280-2S	2	285.5	280	5	80	50	247	14	35	20
SPA300-2S	2	305.5	300	5	80	50	267	14	35	20
SPA315-2S	2	320.5	315	5	80	50	282	14	35	20
SPA355-2S	2	360.5	355	5	80	50	322	14	35	20
SPA400-2S	2	405.5	400	5	90	50	367	14	35	20
SPA450-2S	2	455.5	450	5	100	50	417	14	35	25
SPA500-2S	2	505.5	500	5	100	50	467	16	35	25
SPA560-2S	2	565.5	560	5	100	50	527	18	35	25
SPA600-2S	2	605.5	600	5	110	50	567	18	35	25
SPA630-2S	2	635.5	630	5	110	50	597	18	35	25

Stock Bore V-pulleys

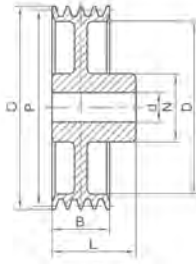

3

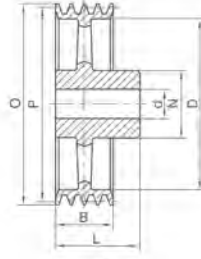

5

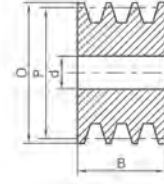

7

SPA-3

ITEM NO.	NO.OF GROOVES	O.D	P.D	TYPE	N	L	D	E	B	d
SPA60-3S	3	65.5	60	7	—	—	—	—	50	10
SPA71-3S	3	76.5	71	1	52	52	—	—	50	10
SPA75-3S	3	80.5	75	7	—	—	—	—	50	10
SPA80-3S	3	85.5	80	7	—	—	—	—	50	15
SPA85-3S	3	90.5	85	7	—	—	—	—	50	15
SPA90-3S	3	95.5	90	7	—	—	—	—	50	15
SPA95-3S	3	100.5	95	7	—	—	—	—	50	15
SPA100-3S	3	105.5	100	7	—	—	—	—	50	15
SPA112-3S	3	117.5	112	7	—	—	—	—	50	15
SPA118-3S	3	123.5	118	7	—	—	—	—	50	15
SPA132-3S	3	137.5	132	7	—	—	—	—	50	15
SPA140-3S	3	145.5	140	3	65	52	107	12	50	15
SPA150-3S	3	155.5	150	3	65	52	117	12	50	20
SPA160-3S	3	165.5	160	3	70	52	127	12	50	20
SPA170-3S	3	175.5	170	3	70	52	137	12	50	20
SPA180-3S	3	185.5	180	3	70	52	147	12	50	20
SPA200-3S	3	205.5	200	3	70	52	167	12	50	20
SPA224-3S	3	229.5	224	3	80	52	192	12	50	20
SPA250-3S	3	255.5	250	3	80	60	217	12	50	20
SPA280-3S	3	285.5	280	5	80	60	247	14	50	20
SPA300-3S	3	305.5	300	5	80	60	267	14	50	20
SPA315-3S	3	320.5	315	5	90	60	282	14	50	20
SPA355-3S	3	360.5	355	5	90	60	322	14	50	20
SPA400-3S	3	405.5	400	5	100	60	367	16	50	25
SPA450-3S	3	455.5	450	5	100	60	417	16	50	25
SPA500-3S	3	505.5	500	5	105	60	467	20	50	25
SPA560-3S	3	565.5	560	5	120	65	527	20	50	25
SPA600-3S	3	605.5	600	5	120	65	567	20	50	25
SPA630-3S	3	635.5	630	5	120	65	597	20	50	25

Stock Bore V-pulleys

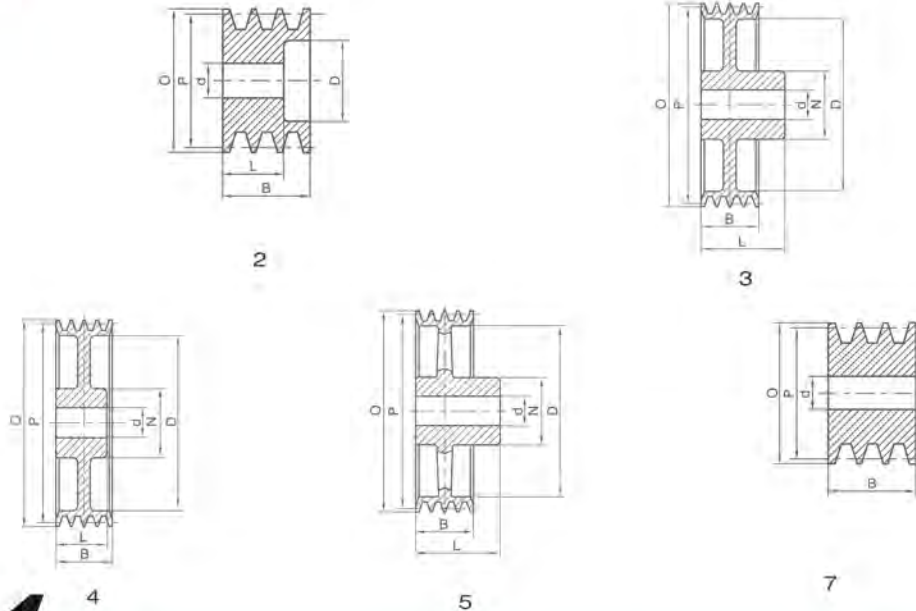

SPA-4

ITEM NO.	NO.OF GROOVES	O.D	P.D	TYPE	N	L	D	E	B	d
SPA75-4S	4	80.5	75	7	—	—	—	—	65	10
SPA80-4S	4	85.5	80	7	—	—	—	—	65	15
SPA85-4S	4	90.5	85	7	—	—	—	—	65	15
SPA90-4S	4	95.5	90	7	—	—	—	—	65	15
SPA95-4S	4	100.5	95	7	—	—	—	—	65	15
SPA100-4S	4	105.5	100	2	—	52	67	—	65	15
SPA112-4S	4	117.5	112	2	—	52	79	—	65	15
SPA118-4S	4	123.5	118	2	—	52	87	—	65	15
SPA132-4S	4	137.5	132	2	—	52	97	—	65	15
SPA140-4S	4	145.5	140	2	—	52	107	—	65	20
SPA150-4S	4	155.5	150	2	—	52	117	—	65	20
SPA160-4S	4	165.5	160	4	70	52	127	12	65	20
SPA170-4S	4	175.5	170	4	80	52	137	12	65	20
SPA180-4S	4	185.5	180	4	80	60	147	12	65	20
SPA200-4S	4	205.5	200	4	80	60	167	12	65	20
SPA224-4S	4	229.5	224	4	90	60	192	12	65	20
SPA250-4S	4	255.5	250	3	90	65	217	12	65	20
SPA280-4S	4	285.5	280	5	90	65	247	14	65	20
SPA300-4S	4	305.5	300	5	90	65	267	14	65	20
SPA315-4S	4	320.5	315	5	90	65	282	14	65	20
SPA355-4S	4	360.5	355	5	90	65	322	16	65	25
SPA400-4S	4	405.5	400	5	100	65	367	20	65	25
SPA450-4S	4	455.5	450	5	105	65	417	20	65	25
SPA500-4S	4	505.5	500	5	105	65	467	20	65	25
SPA560-4S	4	565.5	560	5	120	65	527	22	65	25
SPA600-4S	4	605.5	600	5	120	65	567	22	65	25
SPA630-4S	4	635.5	630	5	120	65	597	22	65	25

Stock Bore V-pulleys

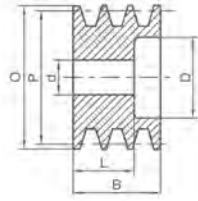

2

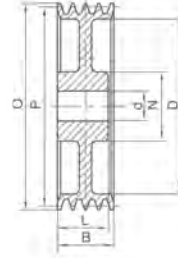

4

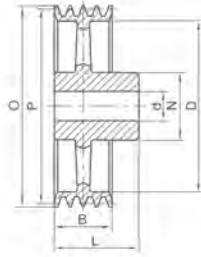

5

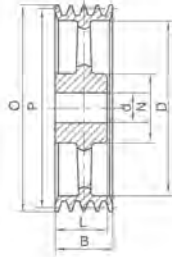

6

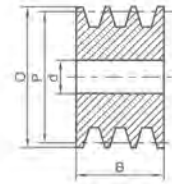

7

SPA-5

ITEM NO.	NO.OF GROOVES	O.D	P.D	TYPE	N	L	D	E	B	d
SPA75-5S	5	80.5	75	7	—	—	—	—	80	10
SPA80-5S	5	85.5	80	7	—	—	—	—	80	15
SPA85-5S	5	90.5	85	7	—	—	—	—	80	15
SPA90-5S	5	95.5	90	7	—	—	—	—	80	15
SPA95-5S	5	100.5	95	7	—	—	—	—	80	15
SPA100-5S	5	105.5	100	2	—	52	67	—	80	15
SPA112-5S	5	117.5	112	2	—	52	79	—	80	15
SPA118-5S	5	123.5	118	2	—	52	87	—	80	15
SPA132-5S	5	137.5	132	2	—	52	97	—	80	15
SPA140-5S	5	145.5	140	2	—	52	107	—	80	20
SPA150-5S	5	155.5	150	2	—	52	117	—	80	20
SPA160-5S	5	165.5	160	4	80	52	127	12	80	20
SPA170-5S	5	175.5	170	4	80	52	137	12	80	20
SPA180-5S	5	185.5	180	4	80	65	147	12	80	20
SPA200-5S	5	205.5	200	4	80	65	167	12	80	20
SPA224-5S	5	229.5	224	4	90	65	192	12	80	20
SPA250-5S	5	255.5	250	4	90	65	217	12	80	20
SPA280-5S	5	285.5	280	6	100	65	247	14	80	25
SPA300-5S	5	305.5	300	6	100	65	267	14	80	25
SPA315-5S	5	320.5	315	6	100	65	282	16	80	25
SPA355-5S	5	360.5	355	6	100	65	322	18	80	25
SPA400-5S	5	405.5	400	6	100	65	367	22	80	25
SPA450-5S	5	455.5	450	6	105	65	417	22	80	25
SPA500-5S	5	505.5	500	6	110	65	467	22	80	25
SPA560-5S	5	565.5	560	5	120	80	527	24	80	25
SPA600-5S	5	605.5	600	5	120	80	567	24	80	25
SPA630-5S	5	635.5	630	5	120	80	597	24	80	25

Stock Bore V-pulleys

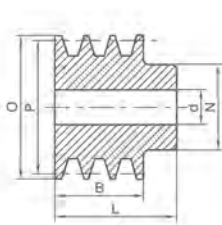

1

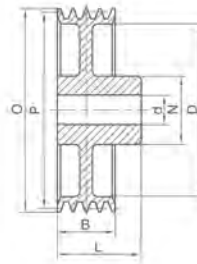

3

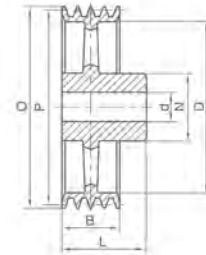

5

SPB-1

ITEM NO.	NO.OF GROOVES	O.D	P.D	TYPE	N	L	D	E	B	d
SPB70-1S	1	77	70	1	45	45	—	—	25	10
SPB80-1S	1	87	80	1	50	45	—	—	25	10
SPB90-1S	1	97	90	1	50	45	—	—	25	10
SPB100-1S	1	107	100	1	52	45	—	—	25	10
SPB112-1S	1	119	112	1	55	45	—	—	25	15
SPB120-1S	1	127	120	1	55	45	—	—	25	15
SPB125-1S	1	132	125	1	58	45	—	—	25	15
SPB132-1S	1	139	132	1	60	45	—	—	25	15
SPB140-1S	1	147	140	1	65	45	—	—	25	20
SPB150-1S	1	157	150	1	65	45	—	—	25	20
SPB160-1S	1	167	160	3	65	45	118	12	25	20
SPB170-1S	1	177	170	3	65	45	128	12	25	20
SPB180-1S	1	187	180	3	65	45	138	12	25	20
SPB200-1S	1	207	200	3	70	45	158	14	25	20
SPB212-1S	1	219	212	3	70	45	170	14	25	20
SPB225-1S	1	232	225	3	70	45	183	14	25	20
SPB250-1S	1	257	250	3	70	50	208	14	25	20
SPB280-1S	1	287	280	3	76	50	238	14	25	20
SPB300-1S	1	307	300	5	76	50	258	15	25	20
SPB315-1S	1	322	315	5	76	50	273	15	25	20
SPB355-1S	1	362	355	5	80	50	313	15	25	20
SPB400-1S	1	407	400	5	85	55	358	18	25	20
SPB450-1S	1	457	450	5	90	60	408	18	25	20
SPB500-1S	1	507	500	5	100	60	458	18	25	25
SPB560-1S	1	567	560	5	100	60	518	18	25	25
SPA600-1S	1	607	600	5	100	60	558	18	25	25
SPB630-1S	1	637	630	5	100	60	588	18	25	25

Stock Bore V-pulleys

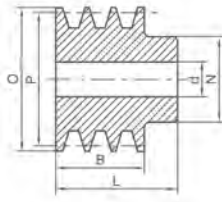

1

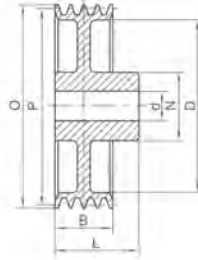

3

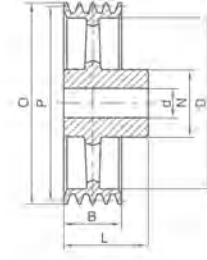

5

SPB-2

ITEM NO.	NO.OF GROOVES	O.D	PD	TYPE	N	L	D	E	B	d
SPB70-2S	2	77	70	1	45	55	—	—	44	10
SPB80-2S	2	87	80	1	50	55	—	—	44	10
SPB90-2S	2	97	90	1	50	55	—	—	44	10
SPB100-2S	2	107	100	1	55	55	—	—	44	15
SPB112-2S	2	119	112	1	60	55	—	—	44	15
SPB120-2S	2	127	120	1	60	55	—	—	44	15
SPB125-2S	2	132	125	1	60	55	—	—	44	15
SPB132-2S	2	139	132	1	60	55	—	—	44	15
SPB140-2S	2	147	140	1	65	55	—	—	44	20
SPB150-2S	2	157	150	1	65	55	—	—	44	20
SPB160-2S	2	167	160	3	70	55	118	12	44	20
SPB170-2S	2	177	170	3	70	55	128	12	44	20
SPB180-2S	2	187	180	3	70	55	138	12	44	20
SPB200-2S	2	207	200	3	70	55	158	12	44	20
SPB212-2S	2	219	212	3	77	55	170	14	44	20
SPB225-2S	2	232	225	3	77	55	183	14	44	20
SPB250-2S	2	257	250	3	77	55	208	14	44	20
SPB280-2S	2	287	280	3	80	55	238	14	44	20
SPB300-2S	2	307	300	5	80	55	258	15	44	20
SPB315-2S	2	322	315	5	88	60	273	15	44	20
SPB355-2S	2	362	355	5	88	60	313	15	44	20
SPB400-2S	2	407	400	5	88	60	358	18	44	20
SPB450-2S	2	457	450	5	90	60	408	18	44	20
SPB500-2S	2	507	500	5	100	65	458	20	44	25
SPB560-2S	2	567	560	5	100	65	518	20	44	25
SPB600-2S	2	607	600	5	100	65	558	20	44	25
SPB630-2S	2	637	630	5	100	65	588	20	44	25

Stock Bore V-pulleys

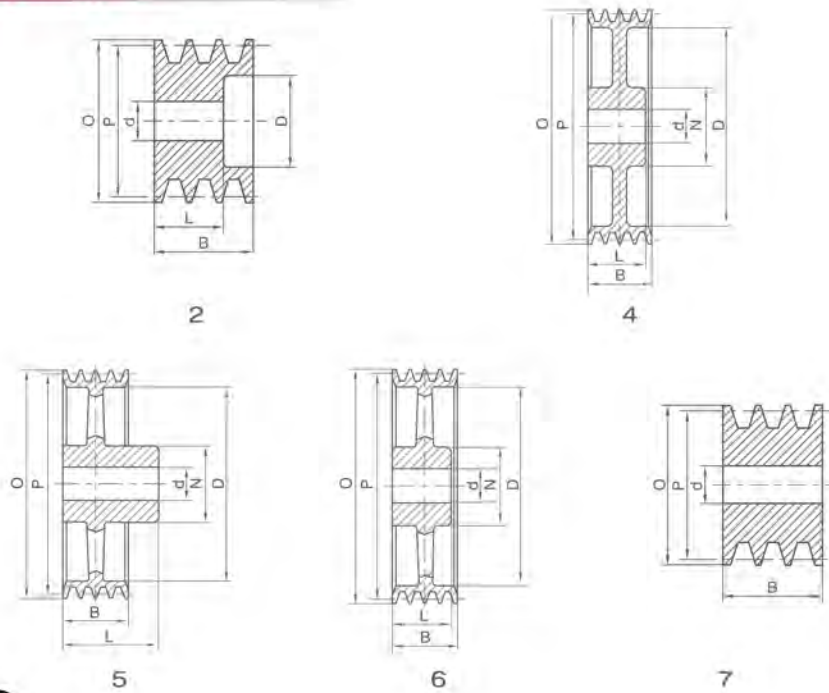

SPB-3

ITEM NO.	NO.OF GROOVES	O.D	P.D	TYPE	N	L	D	E	B	d
SPB80-3S	3	87	80	7	—	—	—	—	63	15
SPB90-3S	3	97	90	7	—	—	—	—	63	15
SPB100-3S	3	107	100	7	—	—	—	—	63	15
SPB112-3S	3	119	112	7	—	—	—	—	63	15
SPB120-3S	3	127	120	7	—	—	—	—	63	15
SPB125-3S	3	132	125	2	—	60	83	—	63	15
SPB132-3S	3	139	132	2	—	60	88	—	63	15
SPB140-3S	3	147	140	2	—	60	98	—	63	20
SPB150-3S	3	157	150	2	—	60	108	—	63	20
SPB160-3S	3	167	160	2	—	60	118	—	63	20
SPB170-3S	3	177	170	4	70	60	128	18	63	20
SPB180-3S	3	187	180	4	80	60	138	18	63	20
SPB200-3S	3	207	200	4	80	60	158	18	63	20
SPB212-3S	3	219	212	4	80	60	170	18	63	20
SPB225-3S	3	232	225	4	80	60	183	18	63	20
SPB250-3S	3	257	250	4	80	60	208	18	63	20
SPB280-3S	3	287	280	4	90	60	238	18	63	20
SPB300-3S	3	307	300	6	90	60	258	18	63	20
SPB315-3S	3	322	315	6	90	60	273	18	63	20
SPB355-3S	3	362	355	6	92	60	313	18	63	25
SPB400-3S	3	407	400	5	96	65	358	22	63	25
SPB450-3S	3	457	450	5	96	65	408	22	63	25
SPB500-3S	3	507	500	5	104	75	458	24	63	25
SPB560-3S	3	567	560	5	104	75	518	24	63	25
SPB600-3S	3	607	600	5	104	75	558	24	63	25
SPB630-3S	3	637	630	5	105	75	588	26	63	25

Stock Bore V-pulleys

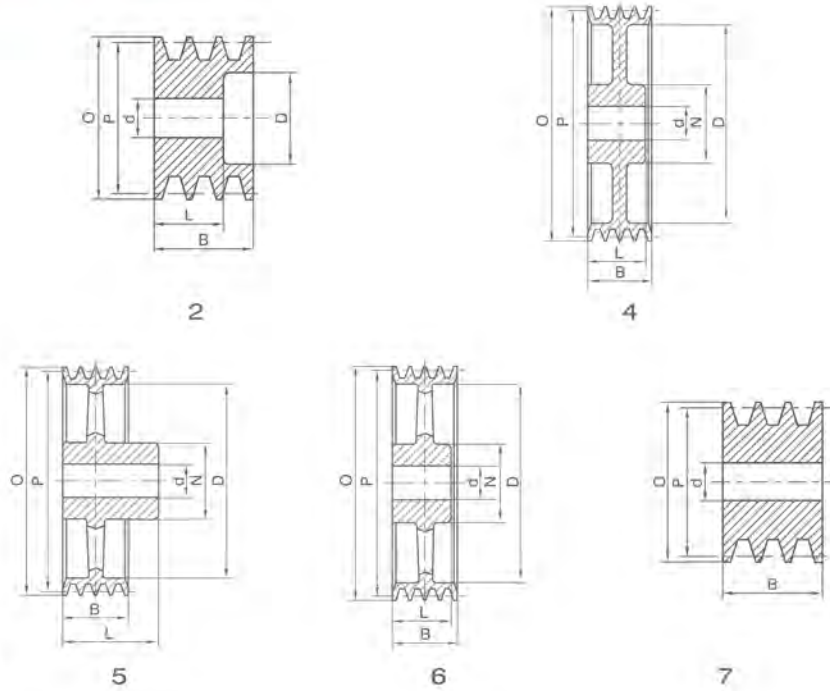

SPB-4

ITEM NO.	NO.OF GROOVES	O.D	PD	TYPE	N	L	D	E	B	d
SPB80-4S	4	87	80	7	—	—	—	—	82	15
SPB90-4S	4	97	90	7	—	—	—	—	82	15
SPB100-4S	4	107	100	7	—	—	—	—	82	15
SPB112-4S	4	119	112	7	—	—	—	—	82	20
SPB120-4S	4	127	120	7	—	—	—	—	82	20
SPB125-4S	4	132	125	2	—	60	83	—	82	20
SPB132-4S	4	139	132	2	—	60	88	—	82	20
SPB140-4S	4	147	140	2	—	60	98	—	82	20
SPB150-4S	4	157	150	2	—	60	108	—	82	20
SPB160-4S	4	167	160	2	—	60	118	—	82	20
SPB170-4S	4	177	170	4	70	60	128	20	82	20
SPB180-4S	4	187	180	4	80	60	138	20	82	20
SPB200-4S	4	207	200	4	88	60	158	25	82	20
SPB212-4S	4	219	212	4	88	60	170	25	82	20
SPB225-4S	4	232	225	4	88	60	183	25	82	20
SPB250-4S	4	257	250	4	96	65	208	25	82	25
SPB280-4S	4	287	280	4	96	65	238	25	82	25
SPB300-4S	4	307	300	6	96	65	258	20	82	25
SPB315-4S	4	322	315	6	96	65	273	20	82	25
SPB355-4S	4	362	355	6	96	65	313	20	82	25
SPB400-4S	4	407	400	6	104	75	358	24	82	25
SPB450-4S	4	457	450	6	104	75	408	24	82	25
SPB500-4S	4	507	500	5	112	85	458	28	82	25
SPB560-4S	4	567	560	5	112	85	518	28	82	25
SPB600-4S	4	607	600	5	115	85	558	28	82	25
SPB630-4S	4	637	630	5	120	85	588	28	82	25

Stock Bore V-pulleys

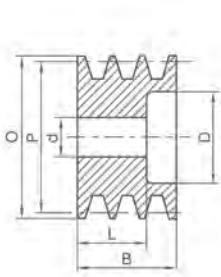

2

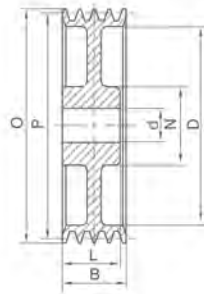

4

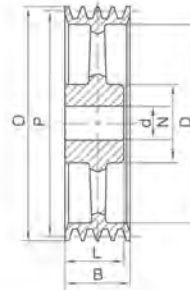

6

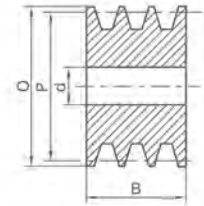

7

SPB-5

ITEM NO.	NO.OF GROOVES	O.D	P.D	TYPE	N	L	D	E	B	d
SPB80-5S	5	87	80	7	—	—	—	—	101	15
SPB90-5S	5	97	90	7	—	—	—	—	101	15
SPB100-5S	5	107	100	7	—	—	—	—	101	15
SPB112-5S	5	119	112	7	—	—	—	—	101	20
SPB120-5S	5	127	120	7	—	—	—	—	101	20
SPB125-5S	5	132	125	2	—	60	83	—	101	20
SPB132-5S	5	139	132	2	—	60	88	—	101	20
SPB140-5S	5	147	140	2	—	60	98	—	101	20
SPB150-5S	5	157	150	2	—	60	108	—	101	20
SPB160-5S	5	167	160	2	—	60	118	—	101	20
SPB170-5S	5	177	170	4	70	60	128	22	101	20
SPB180-5S	5	187	180	4	80	70	138	22	101	20
SPB200-5S	5	207	200	4	96	70	158	25	101	25
SPB212-5S	5	219	212	4	96	70	170	25	101	25
SPB225-5S	5	232	225	4	96	70	183	25	101	25
SPB250-5S	5	257	250	4	104	75	208	25	101	25
SPB280-5S	5	287	280	4	104	75	238	25	101	25
SPB300-5S	5	307	300	6	104	75	258	22	101	25
SPB315-5S	5	322	315	6	104	75	273	22	101	25
SPB355-5S	5	362	355	6	104	75	313	22	101	25
SPB400-5S	5	407	400	6	112	85	358	24	101	25
SPB450-5S	5	457	450	6	112	85	408	26	101	25
SPB500-5S	5	507	500	6	120	90	458	30	101	25
SPB560-5S	5	567	560	6	120	90	518	30	101	25
SPB600-5S	5	607	600	6	120	90	558	30	101	25
SPB630-5S	5	637	630	6	128	90	588	30	101	25

Stock Bore V-pulleys

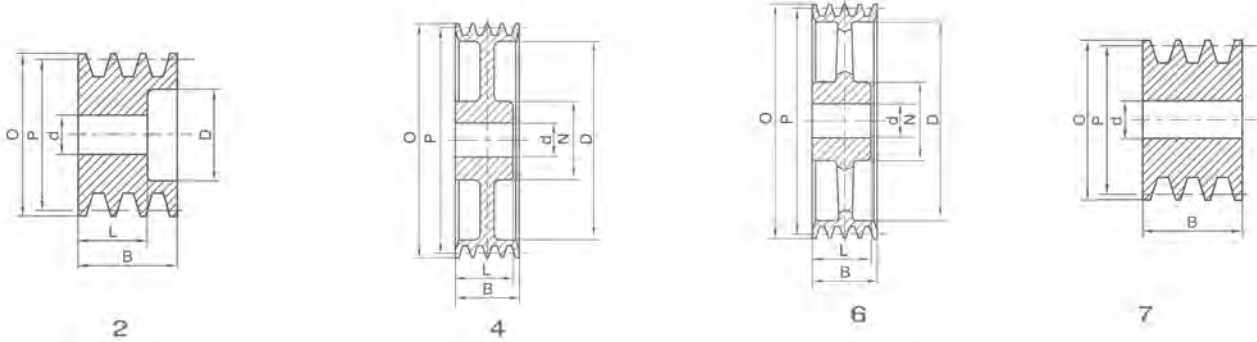

SPB-6

ITEM NO.	NO.OF GROOVES	O.D	PD	TYPE	N	L	D	E	B	d
SPB120-6S	6	127	120	7	—	—	—	—	120	20
SPB125-6S	6	132	125	2	—	60	83	—	120	20
SPB132-6S	6	139	132	2	—	60	88	—	120	20
SPB140-6S	6	147	140	2	—	60	98	—	120	20
SPB150-6S	6	157	150	2	—	60	108	—	120	20
SPB160-6S	6	167	160	2	—	65	118	—	120	20
SPB170-6S	6	177	170	4	70	65	128	22	120	20
SPB180-6S	6	187	180	4	80	70	138	22	120	20
SPB200-6S	6	207	200	4	96	70	158	25	120	25
SPB212-6S	6	219	212	4	104	80	170	25	120	25
SPB225-6S	6	232	225	4	104	80	183	25	120	25
SPB250-6S	6	257	250	4	104	80	208	25	120	25
SPB280-6S	6	287	280	4	104	80	238	25	120	25
SPB300-6S	6	307	300	6	104	80	258	25	120	25
SPB315-6S	6	322	315	6	120	90	273	25	120	25
SPB355-6S	6	362	355	6	120	90	313	25	120	25
SPB400-6S	6	407	400	6	120	100	358	28	120	25
SPB450-6S	6	457	450	6	120	100	408	28	120	25
SPB500-6S	6	507	500	6	129	105	458	33	120	25
SPB560-6S	6	567	560	6	129	105	518	33	120	25
SPB600-6S	6	607	600	6	129	105	558	33	120	25
SPB630-6S	6	637	630	6	140	105	588	33	120	25

Stock Bore V-pulleys

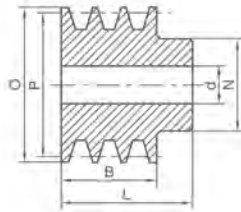

1

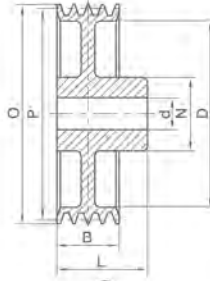

3

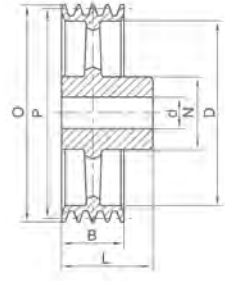

5

SPC-1

ITEM NO.	NO.OF GROOVES	O.D	PD	TYPE	N	L	D	E	B	d
SPC100-1S	1	109.6	100	1	60	50	—	—	34	15
SPC120-1S	1	129.6	120	1	65	50	—	—	34	15
SPC140-1S	1	149.6	140	1	70	50	—	—	34	20
SPC150-1S	1	159.6	150	1	70	50	—	—	34	20
SPC160-1S	1	169.6	160	1	72	50	—	—	34	20
SPC180-1S	1	189.6	180	3	76	50	123	16	34	20
SPC200-1S	1	209.6	200	3	76	50	143	16	34	20
SPC225-1S	1	234.6	225	3	86	50	168	16	34	20
SPC250-1S	1	259.6	250	3	86	50	193	16	34	20
SPC280-1S	1	289.6	280	3	86	50	223	16	34	20
SPC300-1S	1	309.6	300	3	86	50	243	16	34	20
SPC315-1S	1	324.6	315	5	92	50	258	16	34	20
SPC340-1S	1	349.6	340	5	100	50	283	16	34	20
SPC355-1S	1	364.6	355	5	110	50	298	16	34	20
SPC400-1S	1	409.6	400	5	110	60	343	18	34	25
SPC450-1S	1	459.6	450	5	110	60	393	18	34	25
SPC500-1S	1	509.6	500	5	114	60	443	18	34	25
SPC560-1S	1	569.6	560	5	114	60	503	20	34	25
SPC600-1S	1	609.6	600	5	114	60	543	20	34	25
SPC630-1S	1	639.6	630	5	114	60	573	20	34	25

Stock Bore V-pulleys

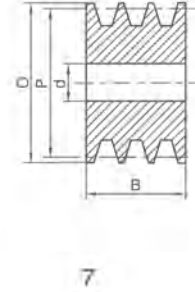
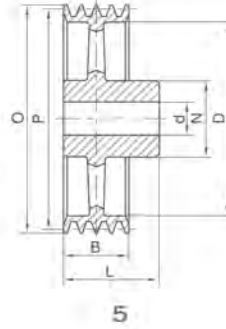
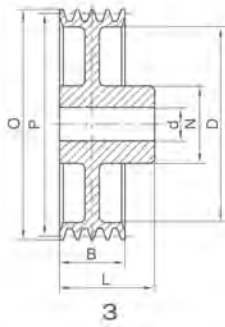

SPC-2

ITEM NO.	NO.OF GROOVES	O.D	P.D	TYPE	N	L	D	E	B	d
SPC120-2S	2	129.6	120	7	—	—	—	—	59.5	15
SPC140-2S	2	149.6	140	7	—	—	—	—	59.5	20
SPC150-2S	2	159.6	150	7	—	—	—	—	59.5	20
SPC160-2S	2	169.6	160	7	—	—	—	—	59.5	20
SPC180-2S	2	189.6	180	3	80	60	123	16	59.5	20
SPC200-2S	2	209.6	200	3	80	60	143	16	59.5	20
SPC225-2S	2	234.6	225	3	88	60	168	18	59.5	20
SPC250-2S	2	259.6	250	3	92	60	193	18	59.5	20
SPC280-2S	2	289.6	280	3	92	60	223	18	59.5	20
SPC300-2S	2	309.6	300	3	92	60	243	18	59.5	20
SPC315-2S	2	324.6	315	5	92	60	258	18	59.5	20
SPC340-2S	2	349.6	340	5	100	60	283	18	59.5	20
SPC355-2S	2	364.6	355	5	110	60	298	18	59.5	25
SPC400-2S	2	409.6	400	5	110	70	343	20	59.5	25
SPC450-2S	2	459.6	450	5	110	70	393	20	59.5	25
SPC500-2S	2	509.6	500	5	114	70	443	20	59.5	25
SPC560-2S	2	569.6	560	5	114	70	503	24	59.5	25
SPC600-2S	2	609.6	600	5	114	70	543	24	59.5	25
SPC630-2S	2	639.6	630	5	114	70	573	24	59.5	25

Stock Bore V-pulleys

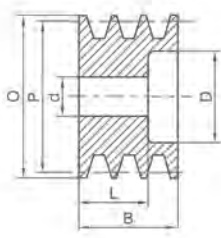

2

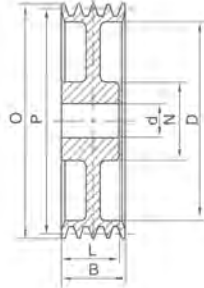

4

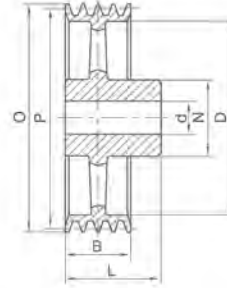

5

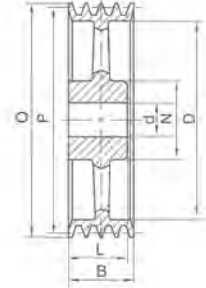

6

SPC-3

ITEM NO.	NO.OF GROOVES	O.D	PD	TYPE	N	L	D	E	B	d
SPC140-3S	3	149.6	140	2	—	65	83	—	85	20
SPC150-3S	3	159.6	150	2	—	65	93	—	85	20
SPC160-3S	3	169.6	160	2	—	65	103	—	85	20
SPC180-3S	3	189.6	180	4	82	65	123	18	85	20
SPC200-3S	3	209.6	200	4	86	65	143	18	85	20
SPC225-3S	3	234.6	225	4	90	70	168	21	85	20
SPC250-3S	3	259.6	250	4	92	70	193	21	85	20
SPC280-3S	3	289.6	280	4	92	70	223	21	85	20
SPC300-3S	3	309.6	300	4	92	70	243	21	85	20
SPC315-3S	3	324.6	315	6	92	70	258	22	85	25
SPC340-3S	3	349.6	340	6	100	70	283	22	85	25
SPC355-3S	3	364.6	355	6	110	70	298	22	85	25
SPC400-3S	3	409.6	400	5	114	90	343	24	85	25
SPC450-3S	3	459.6	450	5	114	90	393	24	85	25
SPC500-3S	3	509.6	500	5	114	90	443	24	85	25
SPC560-3S	3	569.6	560	5	114	90	503	28	85	25
SPC600-3S	3	609.6	600	5	114	90	543	28	85	25
SPC630-3S	3	639.6	630	5	114	90	573	28	85	25

Stock Bore V-pulleys

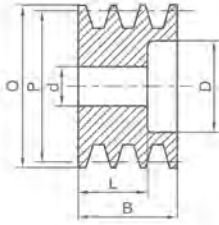

2

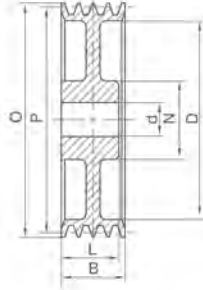

4

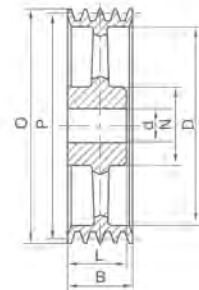

6

SPC-4

ITEM NO.	NO.OF GROOVES	O.D	PD	TYPE	N	L	D	E	B	d
SPC140-4S	4	149.6	140	2	—	80	83	—	110.5	20
SPC150-4S	4	159.6	150	2	—	80	93	—	110.5	20
SPC160-4S	4	169.6	160	2	—	80	103	—	110.5	20
SPC180-4S	4	189.6	180	4	82	80	123	20	110.5	20
SPC200-4S	4	209.6	200	4	90	90	143	25	110.5	20
SPC225-4S	4	234.6	225	4	90	90	168	25	110.5	25
SPC250-4S	4	259.6	250	4	100	90	193	25	110.5	25
SPC280-4S	4	289.6	280	4	100	90	223	25	110.5	25
SPC300-4S	4	309.6	300	4	100	90	243	25	110.5	25
SPC315-4S	4	324.6	315	4	110	90	258	25	110.5	25
SPC340-4S	4	349.6	340	6	114	90	283	25	110.5	25
SPC355-4S	4	364.6	355	6	114	90	298	25	110.5	25
SPC400-4S	4	409.6	400	6	114	90	343	26	110.5	25
SPC450-4S	4	459.6	450	6	120	90	393	28	110.5	25
SPC500-4S	4	509.6	500	6	126	90	443	28	110.5	25
SPC560-4S	4	569.6	560	6	130	90	503	30	110.5	25
SPC600-4S	4	609.6	600	6	130	90	543	30	110.5	25
SPC630-4S	4	639.6	630	6	130	90	573	30	110.5	25

Stock Bore V-pulleys

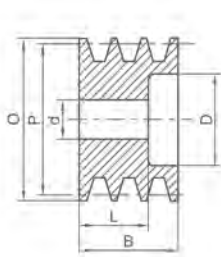

2

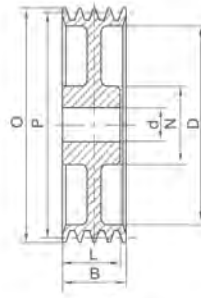

4

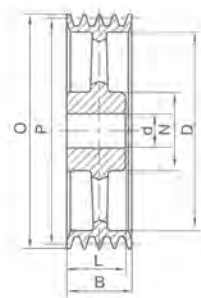

6

SPC-5

ITEM NO.	NO.OF GROOVES	O.D	PD	TYPE	N	L	D	E	B	d
SPC150-5S	5	159.6	150	2	—	96	93	—	136	20
SPC160-5S	5	169.6	160	2	—	96	103	—	136	20
SPC180-5S	5	189.6	180	4	82	96	123	20	136	20
SPC200-5S	5	209.6	200	4	90	100	143	25	136	25
SPC225-5S	5	234.6	225	4	90	100	168	25	136	25
SPC250-5S	5	259.6	250	4	102	100	193	25	136	25
SPC280-5S	5	289.6	280	4	102	100	223	25	136	25
SPC300-5S	5	309.6	300	4	104	100	243	25	136	25
SPC315-5S	5	324.6	315	4	112	100	258	25	136	25
SPC340-5S	5	349.6	340	6	114	100	283	28	136	25
SPC355-5S	5	364.6	355	6	114	100	298	28	136	25
SPC400-5S	5	409.6	400	6	120	100	343	28	136	25
SPC450-5S	5	459.6	450	6	120	100	393	30	136	25
SPC500-5S	5	509.6	500	6	126	100	443	30	136	25
SPC560-5S	5	569.6	560	6	130	100	503	32	136	25
SPC600-5S	5	609.6	600	6	130	100	543	32	136	25
SPC630-5S	5	639.6	630	6	130	100	573	32	136	25

Stock Bore V-pulleys

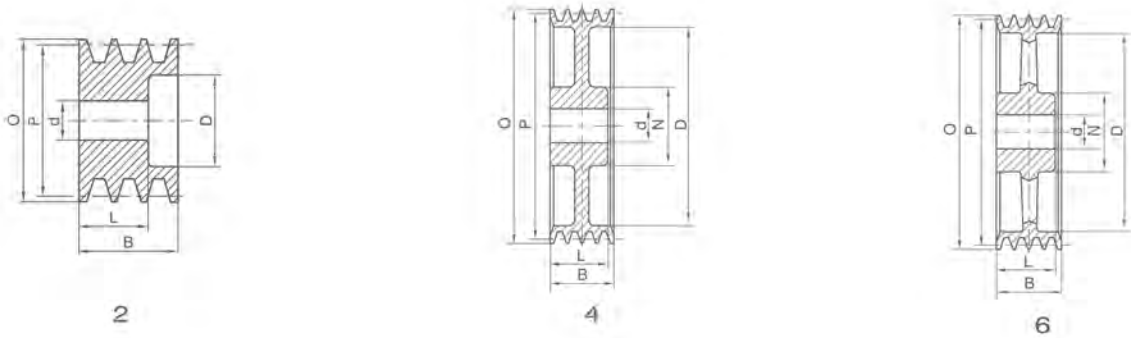

SPC-6

ITEM NO.	NO.OF GROOVES	O.D	P.D	TYPE	N	L	D	E	B	d
SPC160-6S	6	169.6	160	2	—	96	103	—	161.5	20
SPC180-6S	6	189.6	180	4	82	96	123	25	161.5	20
SPC200-6S	6	209.6	200	4	90	100	143	25	161.5	25
SPC225-6S	6	234.6	225	4	90	100	168	25	161.5	25
SPC250-6S	6	259.6	250	4	102	100	193	25	161.5	25
SPC280-6S	6	289.6	280	4	102	100	223	25	161.5	25
SPC300-6S	6	309.6	300	4	104	100	243	25	161.5	25
SPC315-6S	6	324.6	315	4	112	100	258	28	161.5	25
SPC340-6S	6	349.6	340	6	114	100	283	30	161.5	25
SPC355-6S	6	364.6	355	6	114	100	298	30	161.5	25
SPC400-6S	6	409.6	400	6	120	100	343	30	161.5	25
SPC450-6S	6	459.6	450	6	120	100	393	32	161.5	25
SPC500-6S	6	509.6	500	6	126	100	443	32	161.5	25
SPC560-6S	6	569.6	560	6	130	100	503	35	161.5	25
SPC600-6S	6	609.6	600	6	130	100	543	35	161.5	25
SPC630-6S	6	639.6	630	6	130	100	573	35	161.5	25

Adjustable Speed V-pulleys

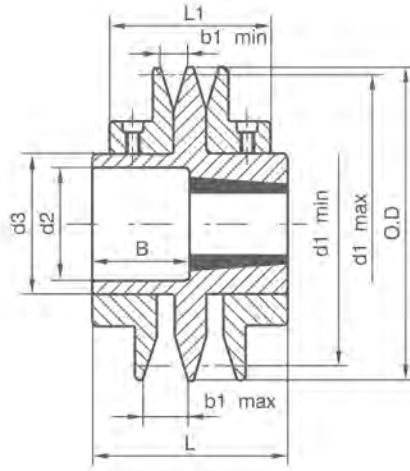

TB-2

ITEM NO.	BUSH	O.D	L	L ₁	d _{max}	b ₁		d ₁		set screws	B	d ₂	d ₃	
						min	max	min	max					
TB108-2	1215	108	73	58	32	13	20.5	75 78 80 83	92 100 92 100	M6×6	34.5	48.5	60	Z 10×6 A 13×8 SPZ SPA
TB120-2	1215	120	73	58	32	13	20.5	87 90 92 95	104 112 104 112	M6×6	34.5	48.5	60	Z 10×6 A 13×8 SPZ SPA
TB138-2	1615	138	73	58	42	13	20.5	105 108 110 113	122 130 122 130	M6×6	34.5	58.5	75	Z 10×6 A 13×8 SPZ SPA
TB160-2	1615	160	87	68	42	17	26.5	117 120 122 128	138 150 138 150	M8×8	48.5	58.5	75	A 13×8 B 17×11 SPA SPB
TB180-2	2012	180	87	68	50	17	26.5	137 140 142 148	158 170 158 170	M8×8	54	71	90	A 13×8 B 17×11 SPA SPB
TB200-2	2012	200	87	68	50	17	26.5	157 160 162 168	177 190 177 190	M8×8	54	71	90	A 13×8 B 17×11 SPA SPB

Adjustable Speed V-pulleys

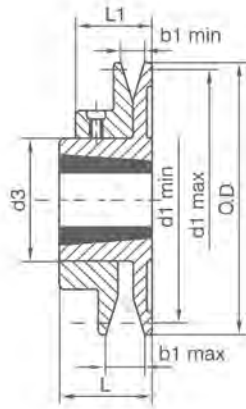

TYPE 1

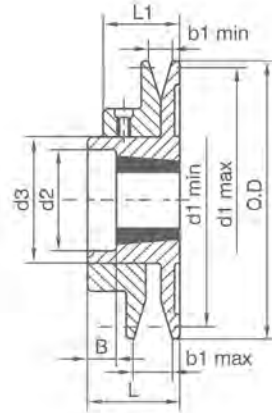

TYPE 2

TB-1

ITEM NO.	TYPE	BUSH	O.D	L	L ₁	dmax	b1		d1		set		B	d ₂	d ₃	
							min	max	min	max	screws					
TB093-1	2	1108	93	36.5	29	28	13	20.5	60 63	78 85	M6×6	13.5	39	50	Z 10×6 A 13×8	
TB108-1	1	1215	108	38	30.5	32	13	20.5	75 78 80 83	92 100 92 100	M6×6	—	—	60	Z 10×6 A 13×8 SPZ SPA	
TB120-1	1	1215	120	38	30.5	32	13	20.5	87 90 92 95	104 112 104 112	M6×6	—	—	60	Z 10×6 A 13×8 SPZ SPA	
TB138-1	1	1615	138	38	30.5	42	13	20.5	105 108 110 113	122 130 122 130	M6×6	—	—	75	Z 10×6 A 13×8 SPZ SPA	
TB160-1	2	1615	160	45	35.5	42	17	26.5	117 120 122 128	138 150 138 150	M8×8	6.5	58	75	A 13×8 B 17×11 SPA SPB	
TB180-1	2	2012	180	45	35.5	50	17	26.5	137 140 142 148	158 170 158 170	M8×8	12.5	71	90	A 13×8 B 17×11 SPA SPB	
TB200-1	2	2012	200	45	35.5	50	17	26.5	157 160 162 168	177 190 177 190	M8×8	12.5	71	90	A 13×8 B 17×11 SPA SPB	

Adjustable Speed V-pulleys

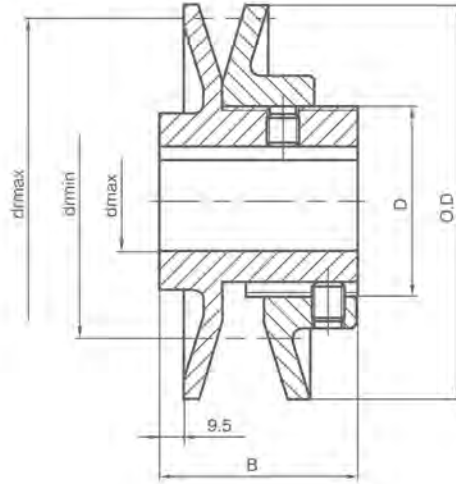

SB-1

ITEM NO.	O.D	D	Bore dmax	B	set screws	dr			kg
						min	max		
SB083-1	83	40	22	48	M6 x 6	58 53	72 72	SPZ Z 10 x 6	0.90
SB093-1	93	45	2	48	M6 x 6	65 68 60 63	78 85 78 85	SPZ SPA Z 10 x 6 A 13 x 8	1.03
SB108-1	108	50	28	48	M6 x 6	80 83 75 78	93 100 93 100	SPZ SPA Z 10 x 6 A 13 x 8	1.65
SB120-1	120	55	28	48	M6 x 6	92 95 87 90	104 112 104 112	SPZ SPA Z 10 x 6 A 13 x 8	1.75
SB138-1	138	55	3	48	M6 x 6	110 113 119 115 108 111	122 130 131 122 130 128	SPZ SPA SPB Z 10 x 6 A 13 x 8 B 17 x 11	2.60
SB160-1	160	80	52	53	M8 x 8	119 122 128 113 117 120	133 140 150 133 138 150	SPZ SPA SPB Z 10 x 6 A 13 x 8 B 17 x 11	4.50
SB180-1	180	80	52	53	M8 x 8	142 148 137 140	160 170 158 170	SPA SPB A 13 x 8 B 17 x 11	5.40

Adjustable Speed V-pulleys

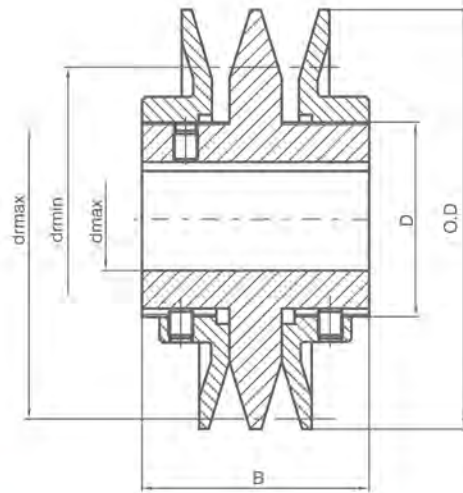

ITEM NO.	O.D	D	Bore d_{max}	B	set screws	dr			kg
						min	max		
SB083-2	83	40	22	76	M6 x 6	58	72	SPZ	1.50
						53	72	Z 10 x 6	
SB093-2	93	45	26	76	M6 x 6	65	78	SPZ	1.75
						68	85	SPA	
						60	78	Z 10 x 6	
						63	85	A 13 x 8	
SB108-2	108	50	28	76	M6 x 6	80	93	SPZ	2..15
						83	100	SPA	
						75	93	Z 10 x 6	
						78	100	A 13 x 8	
SB120-2	120	55	28	76	M6 x 6	92	104	SPZ	2.70
						95	112	SPA	
						87	104	Z 10 x 6	
						90	112	A 13 x 8	
SB138-2	138	55	36	76	M6 x 6	110	122	SPZ	4.50
						113	130	SPA	
						119	131	SPB	
						115	122	Z 10 x 6	
						108	130	A 13 x 8	
						111	128	B 17 x 11	
SB160-2	160	80	52	90	M8 x 8	119	133	SPZ	7.50
						122	140	SPA	
						128	150	SPB	
						113	133	Z 10 x 6	
						117	138	A 13 x 8	
						120	150	B 17 x 11	
SB180-2	180	80	52	90	M8 x 8	142	160	SPA	9.20
						148	170	SPB	
						137	158	A 13 x 8	
						140	170	B 17 x 11	



劲普机械

Jinpu Mechanical

Address: Room 417-1, Building 8, No. 5-4 Yunhe Road, Chongxian Street,
Yuhang District, Hangzhou City, Zhejiang Province, China.

Tel: 86-(0)571-88277778

Fax: 86-(0)571-85853285

E-mail: info@jpmach.com

Website: www.jpmach.com