



劲普机械

Jinpu Mechanical

Hoisting Chains



杭州劲普传动机械有限公司

Hangzhou Jinpu Transmission Mechanical Co., Ltd

www.jpmach.com

中国·浙江

ZHEJIANG CHINA



公司简介 COMPANY PROFILE

Jinpu, An Enterprise in Zhejiang China, is established over 10 years, 50~100 staff, and an area coverage of 5,000+ square meters for 2 manufacturing plants. Our business scope covers manufacturing Sprocket, Gear, Timing Belt Pulley, Taper Bush, Industrial Chain, mainly focus on non-standard machining parts base on customers' drawings.



曳引链 Hoisting chains

车库链 Car parking chains

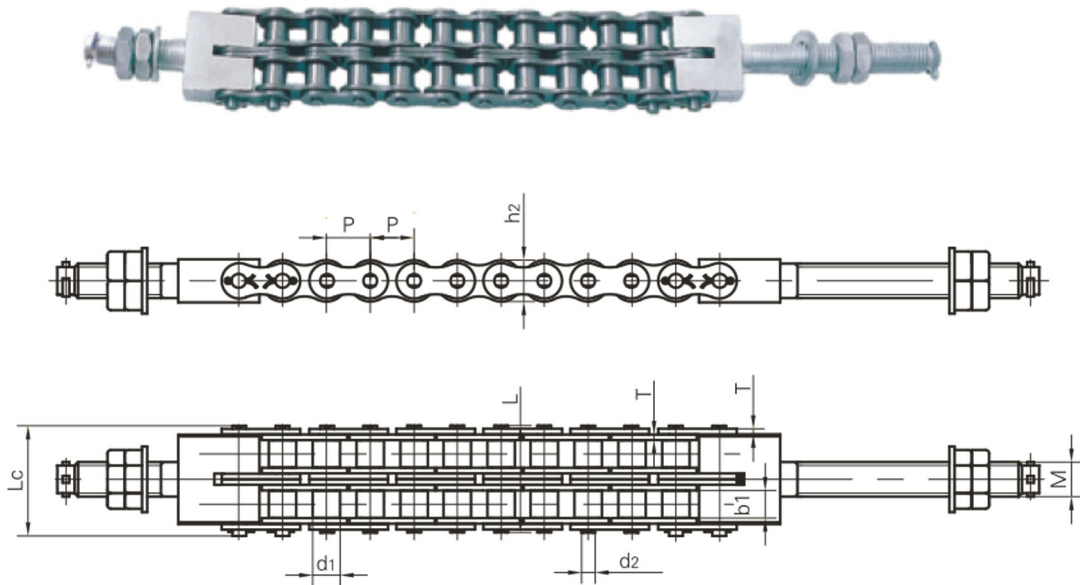

Vision Chain No.	节距	滚子直径	内节内宽	销轴直径	销轴长度		内链板高度	链板厚度	螺栓规格	极限拉伸载荷	平均拉伸载荷	每米长重
	Pitch	Roller diameter	Width between inner plates	Pin diameter	L	L _c	Inner plate depth	Plate thickness	Bolt type	Ultimate tensile strength	Average tensile strength	Weight per meter
	mm	d ₁ max	b ₁ min	d ₂ max	mm	mm	h ₂ max	T max	M	Q min	Q ₀	q
	mm	mm	mm	mm	mm	mm	mm	mm	mm	kN/LB	kN	kg/m
16ALT-1	25.40	15.88	15.75	7.92	32.7	36.5	24.0	3.25	M20	71.55/16261	81.8	2.60
16ALT-2	25.40	15.88	15.75	7.92	62.7	65.8	24.0	3.25	M20	143.10/32523	166.3	5.15
20ALT-1	31.75	19.05	18.90	9.53	40.4	44.7	30.0	4.00	M24	107.85/24511	118.6	3.91
20ALT-2	31.75	19.05	18.90	9.53	76.4	80.5	30.0	4.00	M24	215.70/49023	234.4	7.80
20ALT-3	31.75	19.05	18.90	9.53	112.2	116.3	30.0	4.00	M24	323.55/73534	351.6	11.77
24ALT-1	38.10	22.23	25.22	11.10	50.3	54.3	35.7	4.80	M30	149.20/330909	161.1	5.62
24ALT-2	38.10	22.23	25.22	11.10	95.8	99.7	35.7	4.80	M30	298.40/67818	322.2	11.70

曳引链 Hoisting chains

提升链 Lift chains

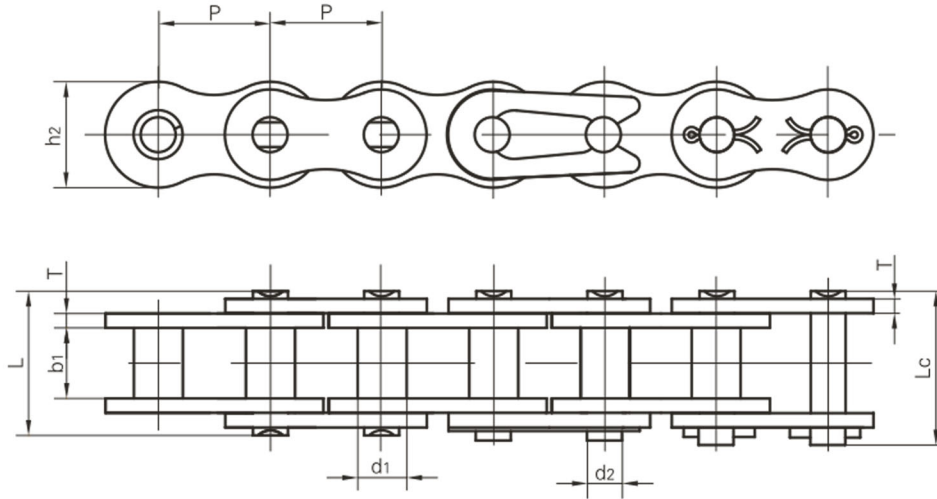

Vision Chain No.	节距	套筒直径	内节内宽	销轴直径	销轴长度		内链板高度	链板厚度	极限拉伸载荷	平均拉伸载荷	每米长重
	Pitch	Bush diameter	Width between inner plates	Pin diameter	Pin length	Pin length	Inner plate depth	Plate thickness	Ultimate tensile strength	Average tensile strength	Weight per meter
	P	d1 max	b1 min	d2 max	L max	Lc max	h2 max	T max	Q min	Q0	q
	mm	mm	mm	mm	mm	mm	mm	mm	kN/LB	kN	kg/m
45-1	12.700	5.63	7.85	3.96	16.6	17.8	12.00	1.50	14.10/3205	17.5	0.54
55-1	15.875	7.03	9.40	5.08	20.7	22.2	15.09	2.03	22.20/5045	29.4	0.83
65-1	19.050	8.33	12.57	5.94	25.9	27.7	18.00	2.42	31.80/7227	41.5	1.22
85-1	25.400	11.10	15.75	7.92	32.7	35.0	24.00	3.25	56.70/12886	69.4	2.16
105-1	31.750	13.60	18.90	9.53	40.4	44.7	30.00	4.00	88.50/20114	109.2	3.31
125-1	38.100	15.60	25.22	11.10	50.3	54.3	35.70	4.80	127.00/28864	156.3	4.97
145-1	44.450	18.00	25.22	12.70	54.4	59.0	41.00	5.60	172.40/39182	212.0	6.50
165-1	50.800	20.00	31.55	14.27	64.8	69.6	47.80	6.40	226.80/51545	278.9	8.70

曳引链 Hoisting chains

板式链 Leaf chains

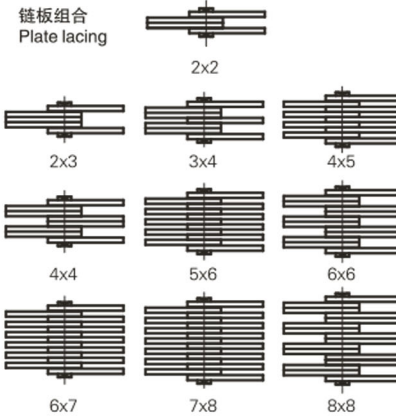
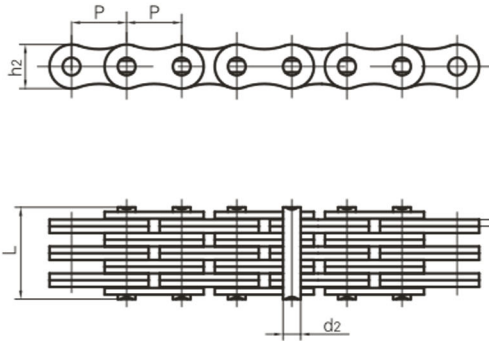

Vision Chain No.	节距	链板组合 plate lacing	链板高度 Plate depth	链板厚度 Plate thickness	销轴直径 Pin diameter	销轴长度 Pin length	链条长度 (100节) Chain length for 100 pitches (±0.25%)	极限拉伸载荷 Ultimate tensile strength	每米长重 Weight per meter
	Pitch		h ₂ max	T max	d ₂ max	L max		Q min	q
	mm		mm	mm	mm	mm	mm	kN/LB	kg/m
1234	12.7	3 X 4	10.6	1.7	4.45	14.2	1262	31.0/6974	0.75
1256		5 X 6				21.1		53.0/12045	1.17
1288		8 X 8				29.9		85.0/19318	1.70
1523	15.875	2 X 3	12.7	1.94	5.08	12.1	1580	29.0/6590	0.75
1534		3 X 4				16.0		46.0/10454	1.04
1544		4 X 4				18.1		58.0/13181	1.18
1545		4 X 5				20.3		58.0/13181	1.33
1556		5 X 6				24.0		72.0/16363	1.63
1566		6 X 6				26.2		87.0/19772	1.77
1567		6 X 7				28.0		90.0/20454	1.91
1578		7 X 8				32.5		101.0/22954	2.2
1588	8 X 8	34.0	115.0/26136	2.34					
1944	19.05	4 X 4	15.0	2.29	5.72	21.3	1891	73.0/16590	1.58
1966		6 X 6				30.7		110.0/25000	2.37
1988		8 X 8				40.0		140.0/31817	3.13
2523	25.4	2 X 3	20.2	3.06	8.28	18.8	2532	72.0/16363	1.83
2534		3 X 4				25.3		108.0/24545	2.55
2545		4 X 5				31.6		144.0/30727	3.26
2556		5 X 6				37.2		180.0/40908	3.96
2567		6 X 7				43.8		216.0/49090	4.68
2578		7 X 8				50.0		252.0/57272	5.39
2588		8 X 8				52.8		290.0/65908	5.77

曳引链 Hoisting chains

板式链 Leaf chains

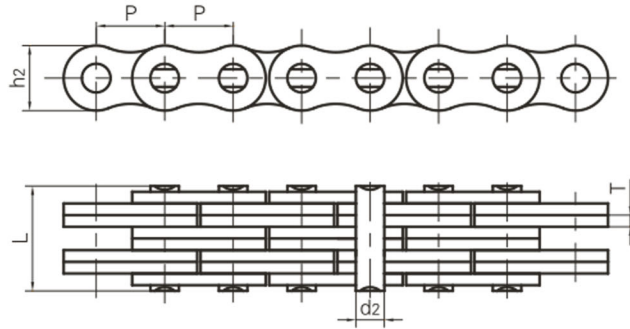
 链板组合
Plate lacing

2x2

3x4



4x4

6x6

8x8

ANSI 链号 ANSI Chain No.	节距 Pitch	链板组合 Plate lacing	链板高度 Plate depth	链板厚度 Plate thickness	销轴直径 Pin diameter	销轴长度 Pin length	极限拉伸载荷 Ultimate tensile strength	平均拉伸载荷 Average tensile strength	每米长重 Weight per meter
	P		h ₂ max	T max	d ₂ max	L max	Q min	Q ₀	q
	mm		mm	mm	mm	mm	kN/LB	kN	kg/m
AL322	9.525	2 X 2	7.7	1.3	3.58	6.8	9.0/2045	10.2	0.23
AL344		4 X 4				11.6	18.0/4090	20.0	0.46
AL422	12.7	2 X 2	10.4	1.5	3.96	8.3	14.1/3205	16.9	0.39
AL444		4 X 4				14.4	28.2/6409	35.2	0.74
AL466		6 X 6				20.5	42.3/9614	52.7	1.13
AL522	15.875	2 X 2	12.8	2.03	5.08	11.05	22.0/5000	27.5	0.64
AL534		3 X 4				17.0	33.0/7500	46.0	1.10
AL544		4 X 4				19.4	44.0/10000	55.0	1.25
AL566		6 X 6				27.5	66.0/15000	82.5	1.79
AL622	19.05	2 X 2	15.6	2.42	5.94	13.0	37.0/8409	44.4	0.86
AL644		4 X 4				22.7	63.7/14450	78.8	1.76
AL666		6 X 6				32.2	100.1/22750	118.6	2.60
AL688		8 X 8				42.2	133.4/30317	156.6	3.49
AL822	25.4	2 X 2	20.5	3.25	7.92	16.0	56.7/12886	68.6	1.54
AL844		4 X 4				29.4	113.4/25773	135.6	3.00
AL866		6 X 6				44.2	170.0/38636	202.3	4.46
AL1022	31.75	2 X 2	25.6	4.0	9.53	19.6	88.5/20114	107.1	2.37
AL1044		4 X 4				36.4	177.0/40227	203.6	4.68
AL1066		6 X 6				52.3	265.0/60227	315.3	7.20
AL1088		8 X 8				68.5	354.0/80454	421.2	9.94
AL1222	38.1	2 X 2	30.5	4.8	11.10	24.3	127.0/28864	151.1	3.65
AL1244		4 X 4				43.8	254.0/57727	299.7	7.05
AL1266		6 X 6				63.2	381.0/86591	426.3	10.50
AL1288		8 X 8				82.6	508.0/11545	568.4	14.03
AL1444		4 X 4				51.3	372.7/84705	413.6	10.34
AL1466	44.45	6 X 6	36.4	5.6	12.64	74.56	559.0/127045	620.4	15.16
AL1644		4 X 4				58.0	471.0/107045	522.8	12.98
AL1666		6 X 6				83.8	706.0/160454	783.6	19.76
AL1688	50.8	8 X 8	41.6	6.4	14.21	109.5	942.0/214090	1045.5	25.47

曳引链 Hoisting chains

板式链 Leaf chains

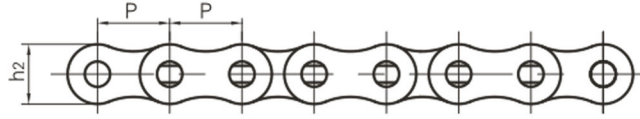

链板组合
Plate lacing



2x2



3x4

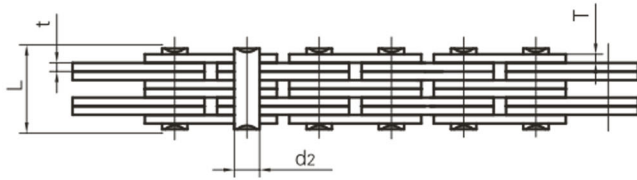

4x4



6x6



8x8

Vision Chain No.	节距	链板组合 plate lacing	链板高度 Plate depth	链板厚度 Plate thickness	销轴直径 Pin diameter	销轴长度 Pin length	极限拉伸载荷 Ultimate tensile strength	平均拉伸载荷 Average tensile strength	每米长重 Weight per meter
	Pitch								
	P								
	mm		h ₂ max	t/T max	d ₂ max	L max	Q min	Q ₀	q
	mm		mm	mm	mm	mm	kN/LB	KN	kg/m
AL0522	8.000	2×2	7.1	0.8	2.31	5.0	4.4/990	4.6	0.15
AL0544		4×4				8.2	8.8/1980	9.3	0.28
AL322F1	9.525	2×2	7.0	1.3	3.58	7.5	9.3/2092	9.8	0.22
AL344F1		4×4				12.8	18.5/4162	19.4	0.42
AL366F1		6×6				18.2	27.8/6254	29.2	0.62
AL388F1		8×8				23.6	37.0/8323	38.8	0.82
AL866F1	25.400	6×6	20.5	3.0	7.92	40.3	135.0/30370	148.5	4.40
AL1266F1	38.100	6×6	30.0	4.8	13.30	64.3	420.0/94482	462.0	9.68
BL866F1	25.400	6×6	24.1	3.1/4.0	10.85	45.7	200.0/44992	220.0	6.14
BL834F2		3×4				29.5	120.0/26995	132.0	3.76
BL834F3	25.400	3×4	24.1	4.0	10.90	32.9	142.0/31944	156.2	4.44
BL866F3		6×6				52.2	253.6/57050	279.0	7.48
BL834F5		3×4		3.1/4.0		28.0	120.0/26995	132.0	3.64
BL866F5		6×6		3.3/4.0		45.3	200.0/44992	220.0	4.94
LL1622F6	25.400	2×2	20.0	3.0	8.28	15.6	58.0/13047	63.8	1.40
LH3288F1	50.800	8×8	47.8	6.9	20.20	122.0	1200.0/269950	1320.0	33.53
LH3266F2	50.800	6×6	48.2	7.0	17.46	91.8	867.0/195040	953.7	24.52
LL3244F2	50.800	4×4	43.1	6.0	17.76	54.0	520.0/116978	572.0	12.62
LL4888H	76.200	8×8	70.0	12.0	36.50	204.0	2630.0/591638	2893.0	83.80

曳引链 Hoisting chains

板式链 Leaf chains

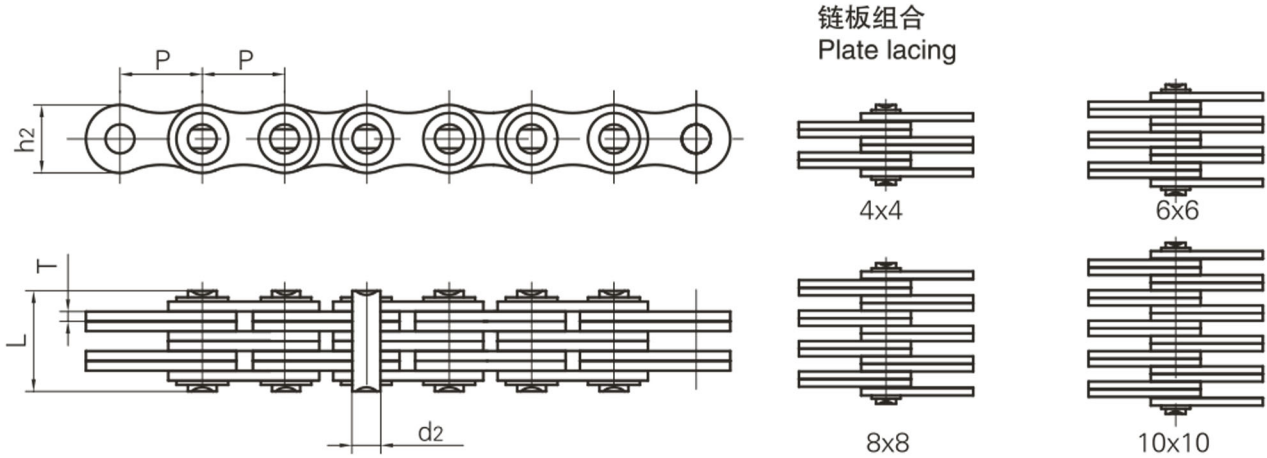

Vision Chain No.	节距 Pitch	链板组合 plate lacing	链板高度 Plate depth	链板厚度 Plate thickness	销轴直径 Pin diameter	销轴长度 Pin length	极限拉伸载荷 Ultimate tensile strength	平均拉伸载荷 Average tensile strength	每米长重 Weight per meter
	P		h2 max	T max	d2 max	L max	Q min	Q0	q
	mm		mm	mm	mm	mm	kN/LB	kN	kg/m
BL1266F1	38.100	6×6	35.7	5.6	12.70	78.9	453.7/102063	499.0	15.69
BL1666F4	50.800	6×6	48.2	7.2	17.46	99.2	867.0/195040	953.7	27.27
LL3244F1	50.800	4×4	42.0	6.0	17.81	61.6	520.0/116978	572.0	12.90
LL3266F1		6×6				780.0/175467	858.0	18.90	
LL3288F1		8×8				1040.0/233956	1144.0	24.89	
LL321010F1		10×10				1300.0/292445	1430.0	30.89	
LL3244F3	50.800	4×4	43.1	6.0	17.76	60.0	520.0/116978	572.0	13.06
LL3266F3		6×6				780.0/175467	858.0	19.44	
LL3288F3		8×8				1040.0/233956	1144.0	25.43	
LL3244F4	50.800	4×4	42.0	6.4	17.81	67.5	520.0/116980	572.0	13.82
LL3266F4		6×6				780.0/175467	858.0	20.17	

曳引链 Hoisting chains

板式链 Leaf chains

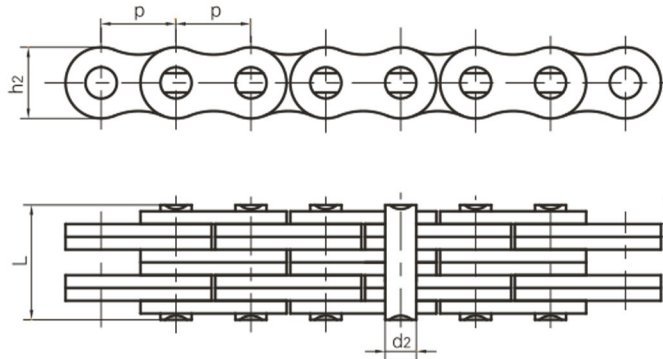
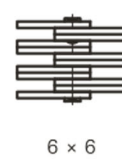
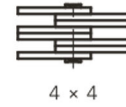
 链板组合
Plate lacing

DIN/ISO 链号	节距 Pitch	链板组合 Plate lacing	链板高度 Plate depth	链板厚度 Plate thickness	销轴直径 Pin diameter	销轴长度 Pin length	极限拉伸载荷 Ultimate tensile strength	平均拉伸载荷 Average tensile strength	每米长重 Weight per meter
DIN/ISO Chain No.	P		h ₂ max	T max	d ₂ max	L max	Q min	Q ₀	q
	mm		mm	mm	mm	mm	kN/LB	kN	kg/m
LL0822	12.7	2 × 2	10.6	1.6	4.45	8.9	18.2/4094	20.4	0.42
LL0844		4 × 4				15.6	36.4/8188	40.7	0.84
LL0866		6 × 6				22.0	54.6/12283	60.0	1.24
LL0888		8 × 8				28.5	72.8/16378	80.0	1.64
LL1022	15.875	2 × 2	13.7	1.6	5.08	9.2	22.7/5107	25.5	0.54
LL1044		4 × 4				15.8	45.4/10213	51.0	1.06
LL1066		6 × 6				22.1	68.1/15321	76.3	1.57
LL1088		8 × 8				28.8	90.8/20427	101.9	2.10
LL1222	19.05	2 × 2	16.0	1.85	5.72	10.4	29.5/6637	33.2	0.73
LL1244		4 × 4				17.9	59.0/13273	66.4	1.44
LL1266		6 × 6				25.4	88.5/19910	99.7	2.15
LL1288		8 × 8				32.9	118.0/26547	132.9	2.84
LL1622	25.4	2 × 2	21.0	3.1	8.28	17.2	58.0/13182	66.7	1.52
LL1644		4 × 4				29.6	116.0/26363	140.0	2.90
LL1666		6 × 6				42.4	174.0/39545	208.8	4.30
LL1688		8 × 8				54.9	232.0/52726	278.0	5.71
LL2022	31.75	2 × 2	26.4	3.5	10.19	20.1	95.0/21591	109.2	2.33
LL2044		4 × 4				33.8	190.0/43182	218.5	4.40
LL2066		6 × 6				50.1	285.0/64773	324.6	6.79
LL2088		8 × 8				64.0	380.0/86363	435.1	8.90

曳引链 Hoisting chains

板式链 Leaf chains

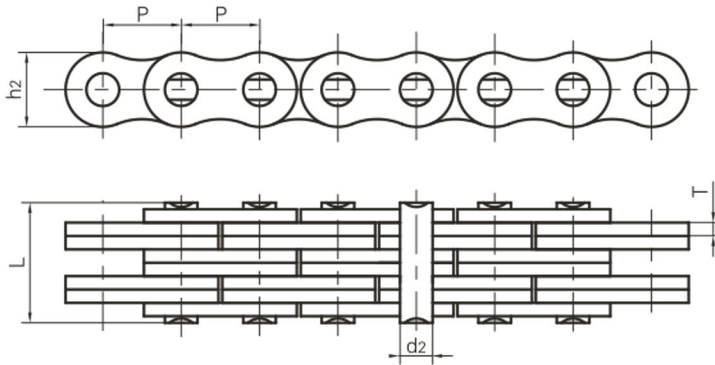

链板组合
Plate lacing

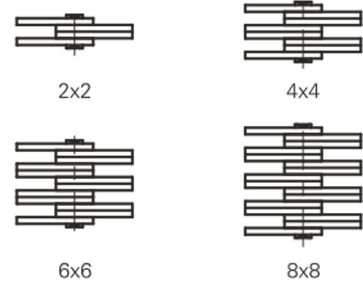

DIN/ISO 链号	节距 Pitch	链板组合 Plate lacing	链板高度 Plate depth	链板厚度 Plate thickness	销轴直径 Pin diameter	销轴长度 Pin length	极限拉伸载荷 Ultimate tensile strength	平均拉伸载荷 Average tensile strength	每米长重 Weight per meter
DIN/ISO Chain No.	P		h ₂ max	T max	d ₂ max	L max	Q min	Q ₀	q
	mm		mm	mm	mm	mm	kN/LB	kN	kg/m
LL2422	38.1	2 × 2	33.4	5.0	14.63	28.4	170.0/38363	195.5	4.47
LL2444		4 × 4				46.3	340.0/77273	380.8	8.22
LL2466		6 × 6				66.4	510.0/115909	571.2	12.22
LL2488		8 × 8				86.6	680.0/154545	775.2	16.30
LL2822	44.45	2 × 2	37.08	6.0	15.90	32.2	200.0/45455	224.0	5.10
LL2844		4 × 4				56.4	400.0/90909	448.0	9.90
LL2866		6 × 6				80.8	600.0/136363	672.0	14.60
LL2888		8 × 8				105.2	800.0/181818	896.0	19.40
LL3222	50.80	2 × 2	42.0	6.4	17.81	34.8	260.0/59091	291.2	6.20
LL3244		4 × 4				60.6	520.0/118182	582.4	12.30
LL3266		6 × 6				86.4	780.0/177272	873.6	18.30
LL3288		8 × 8				112.2	1040.0/233970	1176.0	24.00
LL4022	63.50	2 × 2	52.76	8.0	22.89	42.2	360.0/81818	403.2	10.30
LL4044		4 × 4				74.4	780.0/177273	873.6	20.00
LL4066		6 × 6				106.5	1080.0/245454	1209.6	30.00
LL4088		8 × 8				140.0	1440.0/323959	1747.2	39.10
LL4822	76.20	2 × 2	63.88	10.0	29.24	54.6	560.0/127272	627.2	18.50
LL4844		4 × 4				92.6	1120.0/254545	1554.4	35.70
LL4866		6 × 6				133.4	1680.0/377953	1880.0	53.00
LL4888		8 × 8				174.2	2240.0/509091	2508.8	70.40

曳引链 Hoisting chains

板式链 Leaf chains

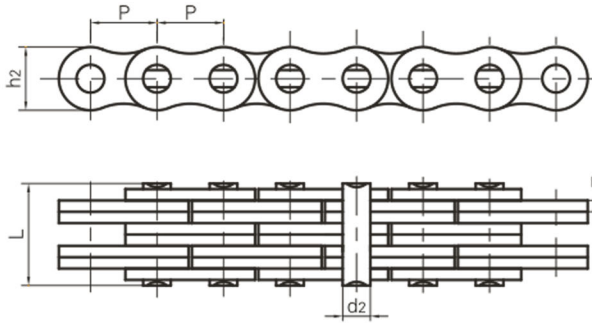
 链板组合
Plate lacing

2x2

2x3

3x4



4x4



4x6



6x6



8x8

ISO 链号 ISO Chain No.	ANSI 链号 ANSI Chain No.	节距 Pitch P mm	链板组合 Plate lacing	链板高度 Plate depth h2 max mm	链板厚度 Plate thickness T max mm	销轴直径 Pin diameter d2 max mm	销轴长度 Pin length L max mm	极限拉伸载荷 Ultimate tensile strength Q min kN/LB	平均拉伸载荷 Average tensile strength Q0 kN	每米长重 Weight per meter q kg/m
LH0822	BL422	12.7	2 × 2	12.07	2.08	5.09	11.05	22.2/5045	27.6	0.64
LH0823	BL423		2 × 3				13.16	22.2/5045	27.6	0.80
LH0834	BL434		3 × 4				17.40	33.4/7591	41.4	1.12
LH0844	BL444		4 × 4				19.51	44.5/10114	56.0	1.28
LH0846	BL446		4 × 6				23.75	44.5/10114	56.0	1.60
LH0866	BL466		6 × 6				27.99	66.7/15159	81.7	1.92
LH0888	BL488		8 × 8				36.45	89.0/20227	109.4	2.56
LH1022	BL522	15.875	2 × 2	15.09	2.44	5.96	12.90	33.4/7591	43.1	0.88
LH1023	BL523		2 × 3				15.37	33.4/7591	43.1	1.10
LH1034	BL534		3 × 4				20.32	48.9/11114	65.6	1.50
LH1044	BL544		4 × 4				22.78	66.7/15159	84.5	1.80
LH1046	BL546		4 × 6				27.74	66.7/15159	84.5	2.20
LH1066	BL566		6 × 6				32.69	100.1/22750	125.1	2.65
LH1088	BL588		8 × 8				42.57	133.4/30318	169.5	3.50
LH1222	BL622	19.05	2 × 2	18.11	3.30	7.94	17.37	48.9/11114	63.6	1.45
LH1223	BL623		2 × 3				20.73	48.9/11114	63.6	1.80
LH1234	BL634		3 × 4				27.43	75.6/17181	102.8	2.50
LH1244	BL644		4 × 4				30.78	97.9/22250	120.9	2.90
LH1246	BL646		4 × 6				37.49	97.9/22250	120.9	3.60
LH1266	BL666		6 × 6				44.20	146.8/33364	190.8	4.30
LH1288	BL688		8 × 8				57.61	195.7/44477	238.8	5.80
LH1622	BL822	25.4	2 × 2	24.13	4.09	9.54	21.34	84.5/19204	108.2	2.20
LH1623	BL823		2 × 3				25.48	84.5/19204	108.2	2.70
LH1634	BL834		3 × 4				33.76	129.0/29318	170.0	3.80
LH1644	BL844		4 × 4				37.90	169.0/38409	214.6	4.30
LH1646	BL846		4 × 6				46.18	169.0/38409	214.6	5.40
LH1666	BL866		6 × 6				54.46	253.6/57636	324.5	6.50
LH1688	BL888		8 × 8				71.02	338.1/76841	432.7	8.60

曳引链 Hoisting chains

板式链 Leaf chains

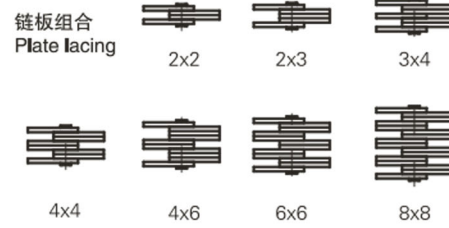
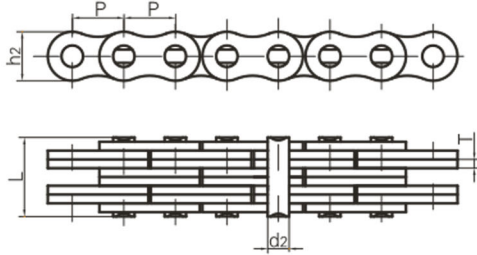

ISO 链号 ISO Chain No.	ANSI 链号 ANSI Chain No.	节距 Pitch P mm	链板组合 Plate lacing	链板高度 Plate depth h ₂ max mm	链板厚度 Plate thickness T max mm	销轴直径 Pin diameter d ₂ max mm	销轴长度 Pin length L max mm	极限拉伸载荷 Ultimate tensile strength Q min kN/LB	平均拉伸载荷 Average tensile strength Q ₀ kN	每米长重 Weight per meter q kg/m
LH2022	BL1022	31.75	2 × 2	30.18	4.9	11.11	25.37	115.6/26272	150.8	3.40
LH2023	BL1023		2 × 3				30.33	115.6/26272	150.8	4.30
LH2034	BL1034		3 × 4				40.23	182.4/41454	231.6	6.00
LH2044	BL1044		4 × 4				45.19	231.3/52568	291.4	6.90
LH2046	BL1046		4 × 6				55.09	231.3/52568	291.4	8.60
LH2066	BL1066		6 × 6				65.00	347.0/78863	430.3	10.30
LH2088	BL1088		8 × 8				84.81	462.6/105136	555.1	13.80
LH2422	BL1222		38.1				2 × 2	36.20	5.77	12.71
LH2423	BL1223	2 × 3		35.43	151.2/34363	192.0	5.8			
LH2434	BL1234	3 × 4		47.07	244.6/55591	315.9	8.1			
LH2444	BL1244	4 × 4		52.88	302.5/68750	381.1	9.3			
LH2446	BL1246	4 × 6		64.52	302.5/68750	381.1	11.6			
LH2466	BL1266	6 × 6		76.15	453.7/103113	543.6	13.9			
LH2488	BL1288	8 × 8		99.42	605.0/137500	726.0	18.6			
LH2822	BL1422	44.45		2 × 2	42.24	6.55	14.29			
LH2823	BL1423		2 × 3	40.16				191.3/43477	225.7	7.6
LH2834	BL1434		3 × 4	53.37				315.8/71772	372.6	10.6
LH2844	BL1444		4 × 4	59.97				382.6/86954	451.2	12.2
LH2846	BL1446		4 × 6	73.18				382.6/86954	451.2	15.2
LH2866	BL1466		6 × 6	86.39				578.3/131431	682.4	18.2
LH2888	BL1488		8 × 8	112.8				765.1/173886	902.8	24.3
LH3222	BL1622		50.8	2 × 2				48.26	7.52	17.46
LH3223	BL1623	2 × 3		46.58	289.1/65704	341.1	10.0			
LH3234	BL1634	3 × 4		61.72	440.4/100091	519.6	14.0			
LH3244	BL1644	4 × 4		69.29	573.8/131431	680.4	16.0			
LH3246	BL1646	4 × 6		84.43	578.3/131431	680.4	20.0			
LH3266	BL1666	6 × 6		99.57	857.4/194863	1000.7	24.0			
LH3288	BL1688	8 × 8		129.84	1156.5/262841	1364.6	32.0			
LH4022	BL2022	63.5		2 × 2	60.33	9.91	23.81			
LH4023	BL2023		2 × 3	61.70				433.7/98568	511.7	19.8
LH4034	BL2034		3 × 4	81.61				649.4/147590	766.2	27.7
LH4044	BL2044		4 × 4	91.57				867.4/197163	1023.5	31.6
LH4046	BL2046		4 × 6	111.48				867.4/197163	1023.5	39.5
LH4066	BL2066		6 × 6	131.39				1301.1/295704	1535.2	47.4
LH4088	BL2088		8 × 8	171.22				1734.8/394272	2046.5	63.2

曳引链 Hoisting chains

板式链 Leaf chains

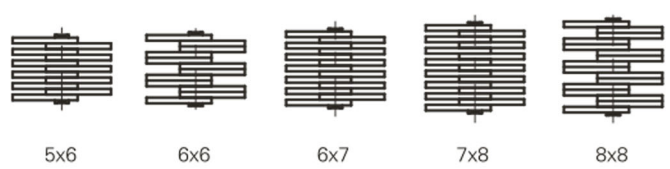
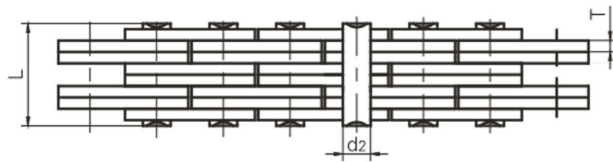
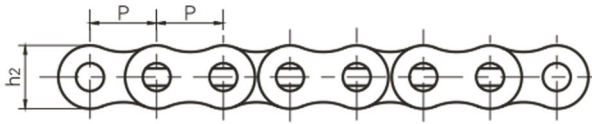
 链板组合
 Plate lacing

Vision Chain No.	节距	链板组合 Plate lacing	链板高度 Plate depth	链板厚度 Plate thickness	销轴直径 Pin diameter	销轴长度 Pin length	极限拉伸载荷 Ultimate tensile strength	平均拉伸载荷 Average tensile strength	每米长重 Weight per meter
	Pitch								
	P								
mm	mm	h ₂ max	T max	d ₂ max	L max	Q min	Q ₀	q	
mm	mm	mm	mm	mm	mm	kN/LB	kN	kg/m	
FL644		4 X 4				6.6	6.5/1477	7.8	0.13
FL666	5.940	6 X 6	4.7	0.60	1.85	9.3	9.75/2216	11.8	0.20
FL688		8 X 8				12.0	13.0/2955	15.6	0.25
FL523	8.000	2 X 3	6.3	1.00	2.31	6.7	7.00/1575	7.4	0.18
FL844		4 X 4	6.9	0.73		7.9	10.0/2273	12.1	0.25
FL944	9.525	4 X 4				10.4	21.0/4724	24.7	0.43
FL945		4 X 5	8.7	1.04	3.28	11.5	21.00/4724	23.0	0.50
FL966		6 X 6				14.9	31.0/7045	36.8	0.65
FL988		8 X 8				19.0	42.00/9450	46.2	0.87
F122	12.700	2 X 2	8.2	1.00	3.58	7.0	11.43/2598	13.6	0.19
F1223		2 X 3	10.2	2.03	4.45	12.8	20.0/4545	23.8	0.61
FL1244		4 X 4	10.2	1.70	4.45	16.7	44.0/10000	52.3	0.83
F1023	15.875	2 X 3	14.3	2.42	4.75	15.9	25.00/5625	27.5	1.11
FLC534	15.875	3 X 4				15.3	40.4/9181	44.4	0.99
FLC545		4 X 5				19.2	54.3/12340	59.7	1.27
FLC556		5 X 6	12.7	1.85	5.08	22.7	67.6/15363	74.3	1.54
FLC567		6 X 7				26.8	80.80/18176	89.0	1.82
FLC578		7 X 8				30.8	90.00/20250	99.0	2.10
LF1866	18.550	6 X 6	15.8	3.00	6.00	39.2	106.00/23845	116.6	3.58

曳引链 Hoisting chains

板式链 Leaf chains

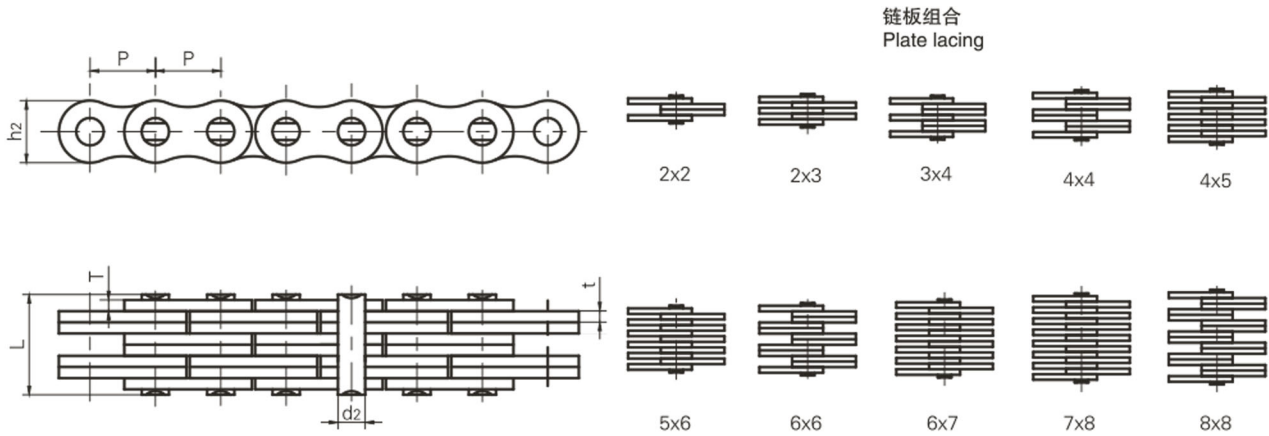

Vision Chain No.	节距	链板组合	链板高度	链板厚度	销轴直径	销轴长度	极限拉伸载荷	平均拉伸载荷	每米长重			
	Pitch	Plate lacing	Plate depth	Plate thickness	Pin diameter	Pin length	Ultimate tensile strength	Average tensile strength	Weight per meter			
	P		h ₂ max	t/T max	d ₂ max	L max	Q min	Q ₀	q			
	mm		mm	mm	mm	mm	kN/LB	kN	kg/m			
F19V-44	19.05	4 X 4	15.20	2.42	6.50	22.4	71.0/16136	84.3	1.73			
F19V-66		6 X 6				32.3				106.0/24090	125.9	2.57
F19S-44	19.05	4 X 4	14.70	2.25	5.98	21.8	76.50/17210	84.5	1.55			
F19S-66		6 X 6				31.0				115.0/25870	126.5	2.31
FLC834	25.40	3 X 4	19.46	3.25	8.28	27.4	100.00/22500	110.0	2.57			
FLC856		5 X 6				40.5				166.00/37343	183.0	4.00
FLC867		6 X 7				47.0				195.70/44024	215.3	4.70
FLC878		7 X 8				53.6				227.50/51180	250.5	5.40
F25-34	25.40	3 X 4	23.40	3.05/4.00	10.85	28.6	125.00/28120	137.5	3.64			
F25-66		6 X 6				44.1				250.00/56240	275.0	5.93
FLC1045	31.75	4 X 5	25.40	3.25	9.53	34.3	110.00/24745	121.0	4.49			
FLC1056		5 X 6				40.6				137.9/31340	151.0	5.44
FLC1067		6 X 7				47.2				165.4/37590	181.9	6.42
FLC1078		7 X 8				53.8				193.0/43863	212.0	7.40

曳引链 Hoisting chains

板式链 Leaf chains

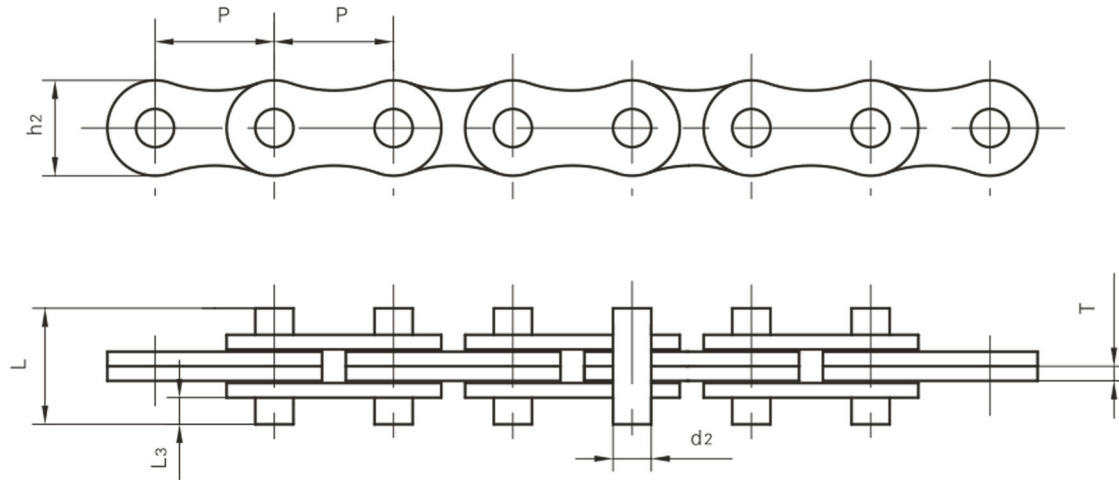

Vision Chain No.	节距 Pitch	链板高度 Plate depth	链板厚度 Plate thickness	销轴直径 Pin diameter	销轴长度 Pin length		极限拉伸载荷 Ultimate tensile strength	平均拉伸载荷 Average tensile strength	每米长重 Weight per meter
	P	h2 max	T max	d2 max	L max	L3	Q min	Q0	q
	mm	mm	mm	mm	mm	mm	kN/LB	KN	kg/m
AL422F1-D2	12.700	11.0	1.60	3.96	14.4	3.80	14.1/3172	15.5	0.50
AL522-D2	15.875	12.8	2.03	5.10	16.0	3.90	22.0/4950	23.0	0.69
AL522F1-D2	15.800	12.7	2.00	5.09	16.1	3.90	30.38/6834	32.0	0.66
AL622F1	19.050	16.9	3.25	5.94	22.3	4.40	50.0/11250	52.0	1.44
LH1622-D2	25.400	24.1	4.00	9.53	36.0	9.80	84.5/19010	93.0	2.83
BL822F1-D2	25.400	24.1	4.60	8.80	32.4	4.60	84.5/19010	93.0	3.03
BL822HF1-D2	25.400	24.1	4.60	9.53	32.4	6.80	84.5/19010	93.0	3.07
BL1022F1-D2	31.750	29.0	5.60	11.30	41.2	5.60	130.0/29245	143.0	4.49
BL1022H-D2	31.750	29.7	5.60	11.10	41.2	8.40	130.0/29245	143.0	4.69
LL1222F3-D2	19.050	14.5	2.25	5.72	22.0	5.72	44.1/9920	48.5	0.89
LL1622-D2	25.400	21.0	3.10	8.28	36.1	11.70	58.0/13050	64.0	1.92
F2022-D2	20.750	19.0	3.40	7.65	23.0	4.50	50.0/11500	55.0	1.79
F2422-D2	23.950	22.2	3.86	8.69	27.8	5.90	60.0/13500	66.0	2.37
F2422F1-D2	24.000	22.0	4.00	9.00	27.0	5.40	60.0/13500	66.0	2.39

曳引链 Hoisting chains

板式链 Leaf chains

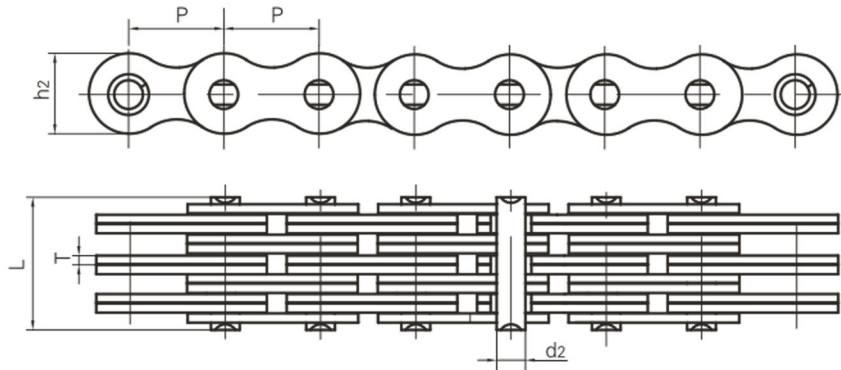

Vision Chain No.	节距 Pitch	链板组合 plate lacing	链板高度 Plate depth	链板厚度 Plate thickness	销轴直径 Pin diameter	销轴长度 Pin length	极限拉伸载荷 Ultimate tensile strength	平均拉伸载荷 Average tensile strength	每米长重 Weight per meter
	P		h2 max	T max	d2 max	L max	Q min	Q0	q
	mm		mm	mm	mm	mm	kN/LB	kN	kg/m
FB156	15.875	6×6	14.7	1.70	5.08	24.0	78.0/17550	86.0	1.91
FB156S				2.03		27.5	83.5/18784	92.0	2.24
FB196	19.050	6×6	16.0	1.85	5.72	25.4	95.0/21371	105.0	1.94
FB196S				2.42		6.50	32.3	130.0/29244	143.0

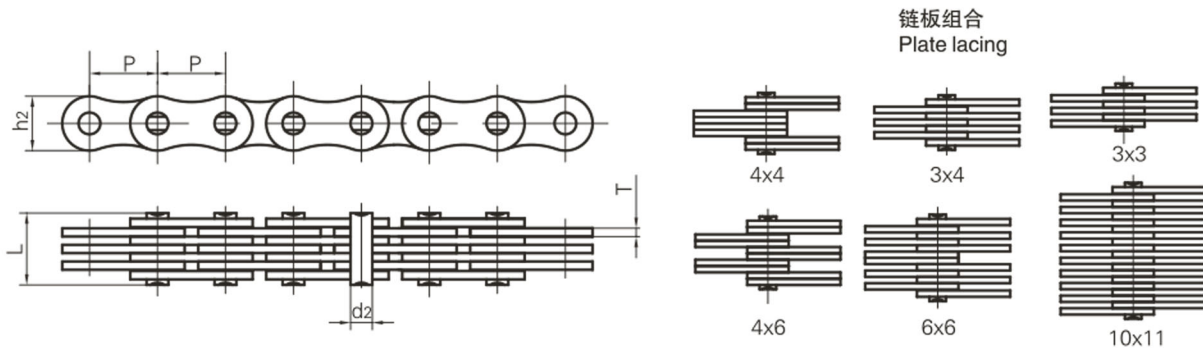

Vision Chain No.	节距 Pitch	链板组合 plate lacing	链板高度 Plate depth	链板厚度 Plate thickness	销轴直径 Pin diameter	销轴长度 Pin length	极限拉伸载荷 Ultimate tensile strength	平均拉伸载荷 Average tensile strength	每米长重 Weight per meter
	P		h2 max	T max	d2 max	L max	Q min	Q0	q
	mm		mm	mm	mm	mm	kN/LB	KN	kg/m
F1266F1	12.700	6×6	9.0	1.60	3.70	21.6	45.0/10123	50.0	0.92
LF10	10.000	3×3	7.5	1.20	3.20	10.6	14.0/3150	15.5	0.39
LF1234	12.000	3×4	10.0	2.03	3.96	17.6	15.45/3476	17.0	0.85
LF1246	12.000	4×6	10.8	1.60	5.08	18.7	30.0/6748	33.0	1.05
LF105	105.000	10×11	80.0	6.00	40.00	143.0	1470.0/330690	115.5	64.38
P35-44	35.000	4×4	30.0	4.00	12.00	37.7	100.0/22500	110.0	5.96

曳引链 Hoisting chains

板式链 Leaf chains

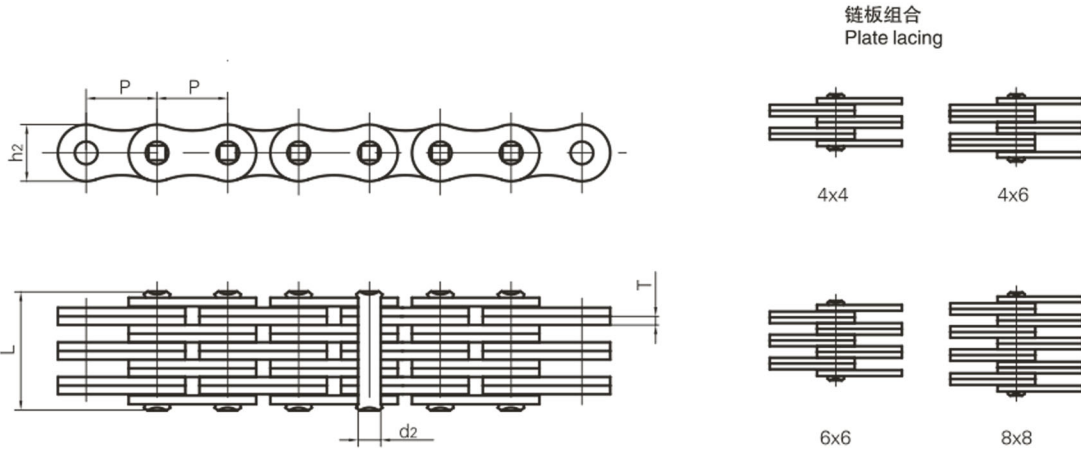

Vision Chain No.	节距	链板组合	链板高度	链板厚度	销轴直径	销轴长度	极限拉伸载荷	平均拉伸载荷	每米长重
	Pitch	plate lacing	plate depth	Plate thickness	Pin diameter	Pin length	Ultimate tensile strength	Average tensile strength	Weight per meter
	P		h2 max	T max	d2 max	L max	Q min	Q0	q
	mm		mm	mm	mm	mm	kN/LB	kN	kg/m
BL1266(DG)	38.10	6×6	35.7	5.6	12.70	79.3	453.7/103113	543.6	15.1
BL1644(DG)		4×4				65.1	573.8/131431	680.4	17.8
BL1646(DG)	50.80	4×6	48.2	7.2	17.46	79.7	578.3/131431	680.4	22.2
BL1666(DG)		6×6				94.2	857.4/194863	1000.7	26.6
BL2088F2(DG)	63.50	8×8	58.2	9.7	23.80	169.5	1734.8/390257	2000.0	41.8
LL3244F2(DG)	50.80	4×4	43.1	6.0	17.76	54.0	520.0/116978	600.0	12.6
LL3288F4(DG)	50.80	8×8	42.0	6.4	17.81	110.5	1040.0/233956	1200.0	25.9
LL4066(DG)	63.50	6×6	52.7	8.0	22.89	106.5	1080.0/242954	1245.0	30.0
LL4088(DG)	63.50	8×8	52.7	8.0	22.89	140.0	1400.0/314940	1610.0	41.3

曳引链 Hoisting chains

销轴链 pin chains

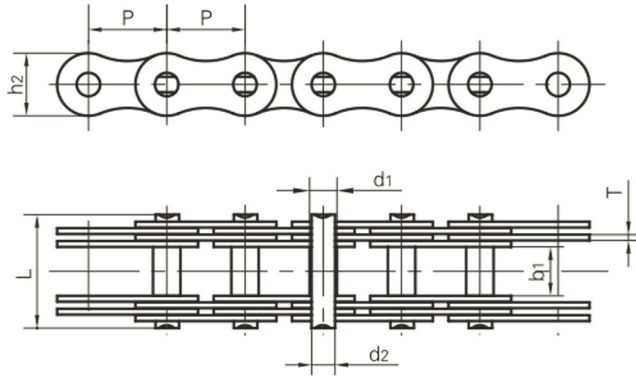
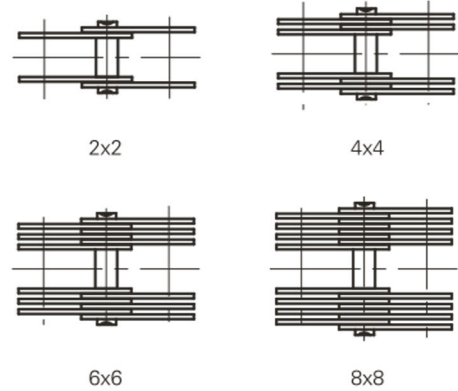
 链板组合
 Plate lacing

Vision Chain No.	节距	内节内宽	链板组合	销轴直径		销轴长度	链板高度	链板厚度	极限拉伸载荷	每米长重
	Pitch	Width between inner plates		Pin diameter		Pin length	Plate depth	Plate thickness	Ultimate tensile strength	Weight per meter
	P	b ₁ min		d ₁ max	d ₂ max	L max	h ₂ max	T max	Q min	q
	mm	mm		mm	mm	mm	mm	mm	kN/LB	kg/m
G15	15	12	2 X 2	5	4	25	12	2.03	5.0/1125	0.7
G20	20	15	2 X 2	8	6	28	15	2.03	12.5/2812	1.1
G25	25	18	2 X 2	10	8	36	18	3.00	25.0/5624	1.8
G30	30	20	4 X 4	11	9	51	20	3.00	40.0/8999	3.4
G35	35	22	4 X 4	12	10	53	26	3.00	60.0/13498	4.5
G40	40	25	4 X 4	14	12	58	32	3.00	80.0/17998	5.0
G45	45	30	4 X 4	17	14	63	35	3.00	100.0/22497	7.0
G50	50	35	4 X 4	22	18	90	40	4.50	150.0/33746	11.3
G55	55	40	4 X 4	24	21	108	42	6.00	200.0/44994	14.5
G60	60	45	4 X 4	26	23	114	46	6.00	250.0/56243	17.1
G70	70	50	6 X 6	32	28	148	55	6.00	375.0/84364	34.0
G80	80	60	6 X 6	36	32	159	60	6.00	500.0/112486	39.0
G90	90	70	6 X 6	40	36	184	70	7.00	750.0/168728	53.0
G100	100	80	8 X 8	45	40	224	80	7.00	1000.0/224972	77.0
G110	110	90	8 X 8	50	45	236	90	7.00	1250.0/281215	90.0
G120	120	100	8 X 8	55	50	262	100	8.00	1500.0/337458	112.0



劲普机械

Jinpu Mechanical

Address: Room 417-1, Building 8, No. 5-4 Yunhe Road, Chongxian Street,
Yuhang District, Hangzhou City, Zhejiang Province, China.

Tel: 86-(0)571-88277778

Fax: 86-(0)571-85853285

E-mail: info@jpmach.com

Website: www.jpmach.com